

DOOR HANDLES  
LOCKS & SECURITY SYSTEMS  
DOOR CONTROL SYSTEMS  
ACCESSORIES  
PATCH FITTINGS  
DIGITAL DOOR LOCK

**dorsët**  
we understand



# Our Business

We are Dorset, an ISO 9001:2015, EMS 14001 : 2015, BS OHSAS 45001 : 2018 organization with over 25 Years of experience as a reputed manufacturer of architectural hardware and provider of high security locking solutions.

We combine new age aesthetics with cutting edge technology. The result is a range of path-breaking products that redefine functionality, reliability and durability.

Our collection includes door handles, door locks, lock accessories, security systems, door control devices, glass hardware, door accessories and electronic safes covering all sectors including homes, offices, establishments and industrial facilities.

Besides adding new segments to our existing range we are in the process of expanding our international presence and further enhancing our quality standards by equipping ourselves with the powers of Automation, Emerging Technologies backed by a full-fledged research unit

comprising four independent R & D cells dedicated to ushering in tomorrow, today.

At the heart of it all is our understanding of the evolving technological scenario and changing consumer needs.

We understand that in order to stay ahead we have to keep innovating to keep delighting our customers.

We have some of the best brains in the industry comprising of people who are techno - commercial having a sense of business & acumen to understand the customer needs and aspirations.

## VISION

To be an enterprising, innovative and profitable global supplier of total access products for homes and workspaces, and to be an employer who understands the importance of creating value for all stakeholders.

## MISSION

"Dorset Inside" We shall strive to create innovative, value-based and trustworthy products for all establishments to ensure a safe and secure living and working environment



Corporate Office: Gurugram



Manufacturing Plant: Gurugram



# Product Overview



Abitare Series



Farretto Series



Premium Series



Stainless Steel Series

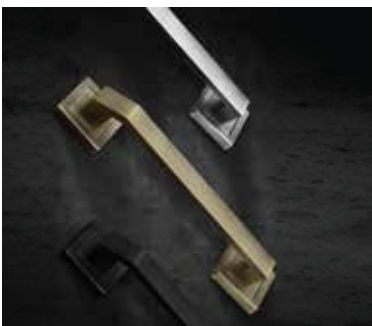

Pull Handle



Combo Lockset Series



Mortise Lock



Euro Profile Cylinder



Door Closer



Phantom Rim Lock



Furniture Lock



Floor Spring



Hinges & Tower Bolt



Glass Solution



Digital Door Lock



Furniture & Kitchen Fitting

**dorsët**  
we understand

**THE APP**  
IS HERE TO  
MAKE YOUR  
LIFE EASIER...



SCAN TO DOWNLOAD  
THE APP

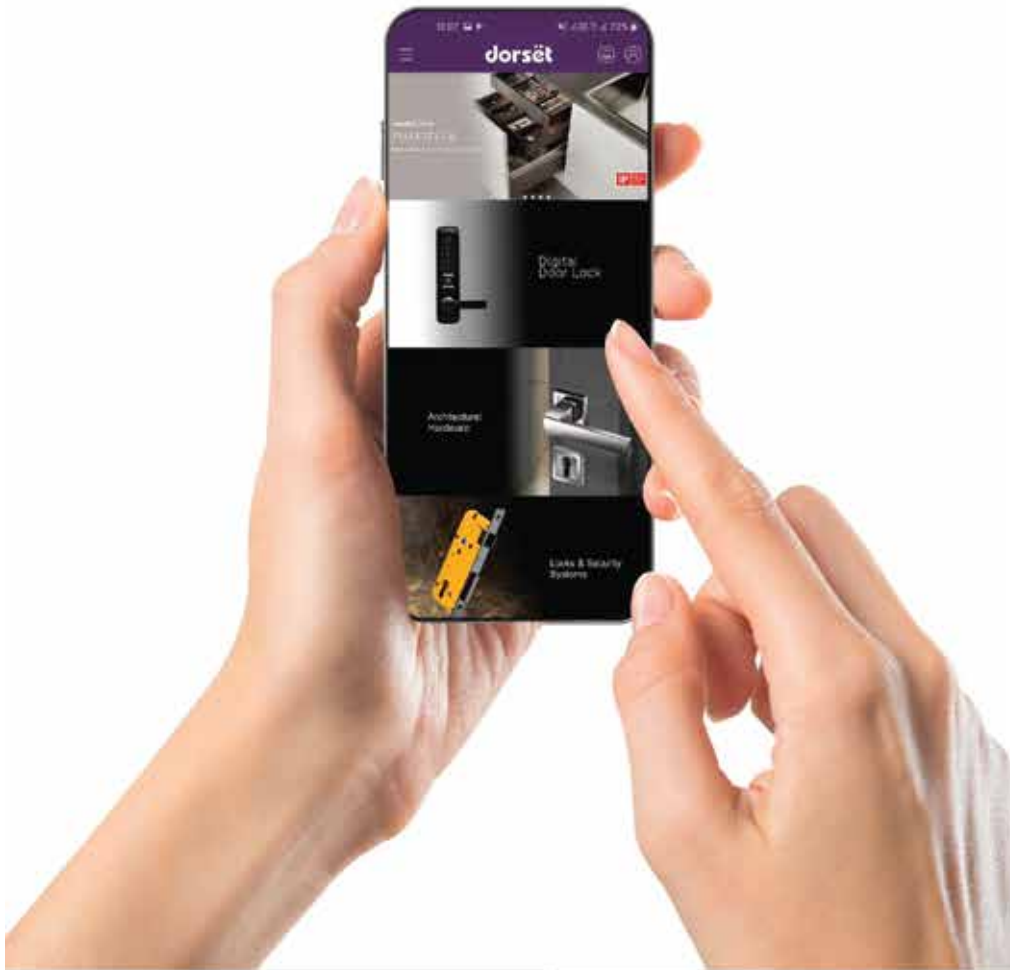

## ADVANCED FEATURES



Latest Product Brochure  
and Price List



Product Installation  
Videos



New Collection  
Launches



Get Instant  
Quotation



Latest Offers



Service Enquiry  
Complaints



Where To Buy



Make Your Own  
Project



GET IT ON  
**Google Play**

Download on the  
**App Store**

[www.dorsetindia.com](http://www.dorsetindia.com)



















Follow us on [f](#) [in](#) [v](#) [i](#)



















# INDEX

|   |         |
|---|---------|
| 1. DIGITAL LOCKS                        | .....01 |
| DIGITAL DOOR LOCK                       | .....01 |
| DIGITAL FURNITURE LOCK                  | .....08 |
| 2. FURNITURE FITTING & KITCHEN HARDWARE | .....10 |
| 3. FIRE RATED PRODUCTS                  | .....26 |
| 4. DOOR HANDLES                         | .....29 |
| ABITARE HANDLES                         | .....29 |
| FARRETTO SERIES                         | .....30 |
| PREMIUM HANDLES                         | .....32 |
| STAINLESS STEEL HANDLES                 | .....34 |
| PREMIUM PULL HANDLES                    | .....36 |
| STAINLESS STEEL PULL HANDLES            | .....38 |
| 5. LOCKS & SECURITY SYSTEMS             | .....39 |
| MORTISE LOCK                            | .....39 |
| EURO PROFILE CYLINDER                   | .....41 |
| PHANTOM & PHANTOM FARRETTO              | .....44 |
| KNOB SET                                | .....46 |
| FURNITURE LOCK                          | .....46 |
| COMBO LOCK SET                          | .....47 |
| 6. DOOR CONTROL SYSTEMS                 | .....64 |
| 7. HINGES & TOWER BOLT                  | .....66 |
| 8. ACCESSORIES                          | .....67 |
| 9. STRAIGHT PATCH FITTING               | .....68 |











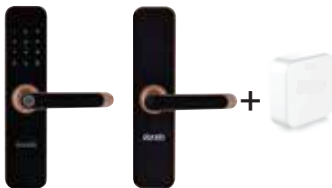





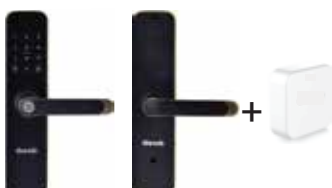

dorsët



| Model   | Variant   | Code       | Description  | MRP     |
|---|---|------------|--|---------|
|    |    | DG 201 IRG | Digital Lock Mortise<br>DG 201 IRG<br>4-in-1 Access<br>(Bio + Pin + Key+ Card)                       | 19405/- |
|    |    | DG 201 MRG | Digital Lock Mortise<br>DG 201 MRG<br>4-in-1 Access<br>(Bio + Pin + Key+ Card)                       | 21170/- |
|    |    | DG 201 IPT | Digital Lock Mortise<br>DG 201 IPT<br>4-in-1 Access<br>(Bio + Pin + Key+ Card)                       | 19405/- |
|   |   | DG 201 MPT | Digital Lock Mortise<br>DG 201 MPT<br>4-in-1 Access<br>(Bio + Pin + Key+ Card)                       | 21170/- |
|  |  | DG 201 IGM | Digital Lock Mortise<br>DG 201 IGM<br>4-in-1 Access<br>(Bio + Pin + Key+ Card)                       | 18520/- |
|  |  | DG 201 MGM | Digital Lock Mortise<br>DG 201 MGM<br>4-in-1 Access<br>(Bio + Pin + Key+ Card)                       | 19845/- |
|  |  | DG 202 IGM | Digital Lock Mortise<br>DG 202 IGM<br>5-in-1 Access<br>(Bio + Pin + Key+ Card)<br>with WiFi In Built | 20615/- |
|  |  | DG 202 MGM | Digital Lock Mortise<br>DG 202 MGM<br>5-in-1 Access<br>(Bio + Pin + Key+ Card)<br>with WiFi In Built | 21720/- |
|  |  | DG 202 ISN | Digital Lock Mortise<br>DG 202 ISN<br>5-in-1 Access<br>(Bio + Pin + Key+ Card)<br>with WiFi In Built | 22040/- |

| Model   | Variant   | Code             | Description  | MRP     |
|---|---|------------------|--|---------|
|    |    | DG 202 MSN       | Digital Lock Mortise<br>DG 202 MSN<br>5-in-1 Access<br>(Bio+Pin + Card+ Key)<br>with WiFi In Built                               | 23140/- |
|    |    | DG 203 IRG       | Digital Lock Mortise<br>DG 203 IRG<br>5-in-1 Access<br>(Bio+Pin + Card+ Key)<br>with BLE In Built                                | 20935/- |
|    |    | DG 203 MRG       | Digital Lock Mortise<br>DG 203 MRG<br>5-in-1 Access<br>(Bio+Pin+Card+Key)<br>with BLE In built                                   | 22155/- |
|   |   | DG 203 IGM       | Digital Lock Mortise<br>DG 203 IGM<br>5-in-1 Access<br>(Bio+Pin+Card+Key)<br>with BLE In built                                   | 19625/- |
|  |  | DG 203 MGM       | Digital Lock Mortise<br>DG 203 MGM<br>5-in-1 Access<br>(Bio+Pin+Card+Key)<br>with BLE In built                                   | 20725/- |
|  |  | DG 203 MPT       | Digital Lock Mortise<br>DG 203 MPT<br>5-in-1 Access<br>(Bio+Pin+Card+Key)<br>with BLE In built                                   | 22155/- |
|  |  | DG 204 MRG       | Digital Lock Mortise<br>DG 204 MRG<br>5-in-1 Access<br>(Bio+Pin+Card+Key)<br>With Wifi In built &<br>integrated Camera           | 29610/- |
|  |  | DG 204 MGM       | Digital Lock Mortise<br>DG 204 MGM<br>5-in-1 Access<br>(Bio+Pin+Card+Key)<br>With Wifi In built &<br>integrated Camera           | 28035/- |
|  |  | DG 203 IRG Combo | Digital Lock Mortise<br>DG 203 IRG Combo<br>5-in-1 Access<br>(Bio+Pin + Card+ Key)<br>with BLE In built<br>& Wifi Gateway Module | 23915/- |



















| Model   | Variant   | Code             | Description  | MRP     |
|---|---|------------------|--|---------|
|    |    | DG 203 MRG Combo | Digital Lock Mortise<br>DG 203 MRG Combo<br>5-in-1 Access<br>(Bio+Pin + Card+ Key)<br>with BLE In built<br>& Wifi Gateway Module | 25130/- |
|    |    | DG 203 IGM Combo | Digital Lock Mortise<br>DG 203 IGM Combo<br>5-in-1 Access<br>(Bio+Pin + Card+ Key)<br>with BLE In built<br>& Wifi Gateway Module | 22600/- |
|    |    | DG 203 MGM Combo | Digital Lock Mortise<br>DG 203 MGM Combo<br>5-in-1 Access<br>(Bio+Pin + Card+ Key)<br>with BLE In built<br>& Wifi Gateway Module | 23705/- |
|   |   | DG 203 MPT Combo | Digital Lock Mortise<br>DG 203 MPT Combo<br>5-in-1 Access<br>(Bio+Pin + Card+ Key)<br>with BLE In built<br>& Wifi Gateway Module | 25130/- |
|  |  | DG 401 IRG       | Digital Pull Lock<br>DG 401 IRG<br>4-in-1 Access<br>(Bio + Pin + Key+ Card)<br>BLE -Optional                                     | 45675/- |
|  |  | DG 801 MGM       | Digital Lock BLE DG 801 MGM<br>WITH CLOUD KEY<br>5-in-1 Access<br>(Bio+Pin + Card+ Key)<br>with BL & Cloud Key                   | 49510/- |
|  |  | DG 801 IGM       | Digital Lock BLE DG 801 IGM<br>WITH CLOUD KEY<br>5-in-1 Access<br>(Bio+Pin + Card+ Key)<br>with BL & Cloud Key                   | 47250/- |
|  |  | DG 501 MGM       | Digital Lock Mortise<br>DG 501 MGM<br>4-in-1 Access<br>(Bio + Pin + Key+ Card)<br>BLE -Optional                                  | 40425/- |
|  |  | DG 501 IGM       | Digital Lock Mortise<br>DG 501 IGM<br>4-in-1 Access<br>(Bio + Pin + Key+ Card)<br>BLE -Optional                                  | 38155/- |











| Model   | Variant   | Code       | Description   | MRP     |
|---|---|------------|---|---------|
|    |    | DG 503 MGM | Digital Lock Mortise<br>DG 503 MGM<br>3-in-1 Access<br>(Bio + Pin + Key)<br>BLE -Optional | 36750/- |
|    |    | DG 503 IGM | Digital Lock Mortise<br>DG 503 IGM<br>3-in-1 Access<br>(Bio + Pin + Key)<br>BLE -Optional | 34545/- |
|    |    | DG 503 MRG | Digital Lock Mortise<br>DG 503 MRG<br>3-in-1 Access<br>(Bio + Pin + Key)<br>BLE -Optional | 37800/- |
|   |   | DG 503 IRG | Digital Lock Mortise<br>DG 503 IRG<br>3-in-1 Access<br>(Bio + Pin + Key)<br>BLE -Optional | 35595/- |
|  |  | DG 502 MGM | Digital Lock Mortise<br>DG 502 MGM<br>3-in-1 Access<br>(Pin + Card+ Key)<br>BLE -Optional | 27825/- |
|  |  | DG 502 IGM | Digital Lock Mortise<br>DG 502 IGM<br>3-in-1 Access<br>(Pin + Card+ Key)<br>BLE -Optional | 25620/- |
|  |  | DG 502 MRG | Digital Lock Mortise<br>DG 502 MRG<br>3-in-1 Access<br>(Pin + Card+ Key)<br>BLE -Optional | 28875/- |
|  |  | DG 502 IRG | Digital Lock Mortise<br>DG 502 IRG<br>3-in-1 Access<br>(Pin + Card+ Key)<br>BLE -Optional | 26670/- |
|  |  | DG 504 MGM | Digital Lock Mortise<br>DG 504 MGM<br>2-in-1 Access<br>(Pin + Key)<br>BLE -Optional       | 23625/- |

| Model   | Variant   | Code       | Description  | MRP     |
|---|---|------------|--|---------|
|    |    | DG 504 IGM | Digital Lock Mortise<br>DG 504 IGM<br>2-in-1 Access<br>(Pin + Key)<br>BLE -Optional                            | 21420/- |
|    |    | DG 504 MRG | Digital Lock Mortise<br>DG 504 MRG<br>2-in-1 Access<br>(Pin + Key)<br>BLE -Optional                            | 24675/- |
|    |    | DG 504 IRG | Digital Lock Mortise<br>DG 504 IRG<br>2-in-1 Access<br>(Pin + Key)<br>BLE -Optional                            | 22470/- |
|   |   | DG 101 MGM | Digital Lock Mortise<br>DG 101 MGM<br>4-in-1 Access<br>(Bio+Pin+Card+Key)                                      | 18185/- |
|  |  | DG 101 GM  | Digital Lock Mortise<br>DG 101 GM<br>4-in-1 Access<br>(Bio+Pin+Card+Key)                                       | 16780/- |
|  | Rim   | DG 806 GM  | Digital Lock RIM<br>DG 806 GM<br>2-in-1 Access<br>(Pin + Card)   | 10695/- |
|  | Rim   | DG 906 GM  | Digital Lock RIM<br>DG 906 GM<br>2-in-1 Access<br>(Pin + Card)<br>Verti Lock Body Suitable for<br>Narrow Stile | 11575/- |
|  | Rim   | DG 906 SL  | Digital Lock RIM<br>DG 906 SL<br>2-in-1 Access<br>(Pin + Card)<br>Suitable for Sliding Door                    | 13120/- |
|  | Rim   | DG 807 GM  | Digital Lock RIM<br>DG 807 GM<br>1-in-1 Access<br>(Pin)  | 9020/-  |

| Model   | Variant      | Code         | Description   | MRP     |
|---|--------------|--------------|---|---------|
|    | Rim          | DG 907 GM    | Digital Lock RIM<br>DG 907 GM<br>1-in-1 Access<br>(Pin)<br>Verti Lock body Suitable for<br>Narrow Stile | 9590/-  |
|    | Rim          | DG 601 GM    | Digital Lock RIM<br>DG 601 GM<br>4-in-1 Access<br>(Bio + Pin + Key+ Card)                               | 31500/- |
|    | Rim          | DG 603 GM    | Digital Lock RIM<br>DG 603 GM<br>3-in-1 Access<br>(Bio + Pin + Key)                                     | 27300/- |
|     | Glass<br>Rim | DG 705 GM    | Digital Lock Glass<br>DG 705 GM<br>3-in-1 Access<br>(Bio+Card+ Pin)                                     | 31290/- |
|   | Glass<br>Rim | DG 705 GM(R) | Digital Lock Glass<br>DG 705 GM With RX<br>3-in-1 Access with remote<br>(Bio+Card+ Pin)                 | 39900/- |

|   | Model   | Code                 | Description                              | MRP              |
|---|---|----------------------|--|------------------|
| Digital Furniture/Cabinet/Wardrobe Lock |    | DG 303/<br>DG 303 FG | Biometric Lock (Up to 20 Unique Access)  | 4380/-<br>4370/- |
|   |    | DG 303 SL            | Biometric Lock (Up to 20 Unique Access)  | 4570/-           |
|   |    | DG 304               | Biometric Lock (Up to 40 Unique Access)  | 3125/-           |
|   |    | DG 304 SL            | Biometric Lock (Up to 40 Unique Access)  | 3175/-           |
|   |    | DG 305               | Biometric Lock (Up to 40 Unique Access)  | 4790/-           |
|   |    | DG 306               | Password 4 to 15 Digits & Mechanical Key | 2190/-           |
|   |    | DG 307               | Biometric Lock (Up to 20 Unique Access)  | 5000/-           |
|   |  | DG 308 FG            | Biometric Lock (Up to 20 Unique Access)  | 4590/-           |

| Accessories   | Name                                   | Code          | Description   | MRP    |
|---|--|---------------|---|--------|
|  | BLE Kit for DG 500 Series & DG 401     | BLE DG 50     | It includes BLE Module                              | 4200/- |
|  | Wifi Kit for DG 200 Series             | DG20WIFI      | It includes Wifi Gateway Module                     | 5250/- |
|  | Remote Kit for DG 500 Series           | RE DG 50 NEW  | It includes Rx Module and Remote                    | 9200/- |
|  | Remote Kit for DG 600 Series           | RE DG 601/603 | It includes Rx Module and Remote                    | 9200/- |
|  | Remote Kit for DG 600 Series           | RE DG 606/607 | It includes Rx Module and Remote                    | 9200/- |
|  | Remote Kit for DG 806/807              | RE DG 806/807 | It includes Rx Module and Remote                    | 9200/- |
|  | Remote Kit for DG 906/907              | RE DG 906/907 | It includes Rx Module and Remote                    | 9200/- |
|  | Video Door Phone Module for 200 Series | VDP DG 200    | It include Rx & Tx for configuring Video Door Phone | 9649/- |

| Accessories   | Name                                   | Code          | Description   | MRP    |
|---|--|---------------|---|--------|
|    | Video Door Phone Module for 500 Series | VDP DG 50 NEW | It include Rx & Tx for configuring Video Door Phone | 9650/- |
|    | Video Door Phone Module for 601/603    | VDP 601/603   | It include Rx & Tx for configuring Video Door Phone | 9650/- |
|    | Video Door Phone Module for 606/607    | VDP 606/607   | It include Rx & Tx for configuring Video Door Phone | 9650/- |
|    | Video Door Phone Module for 806/807    | VDP 806/807   | It include Rx & Tx for configuring Video Door Phone | 9650/- |
|    | Video Door Phone Module for 801        | VDP DG 801    | It include Rx & Tx for configuring Video Door Phone | 9650/- |
|   | RFID Card                              | DG CARD       | Dorset branded RFID card                            | 400/-  |
|  | RFID Tag                               | DG TAG        | RFID Tag  | 400/-  |
|  | RFID Sticker                           | DG STCR       | Smart RFID Sticker                                  | 300/-  |
|  | Glass Double Door Striker Plate        | DG DDA        | Glass Double Door Striker Plate                     | 4300/- |
|  | Extended Warranty Card                 | EWC DG        | 1 Year Extended warranty Card                       | 2400/- |

# FURNITURE FITTINGS & KITCHEN HARDWARE

**dorsët**  
we understand

HINGE SYSTEM

iGEN

BALL BEARING SLIDE SYSTEM

iSLIDE

SOFT CLOSE BALL BEARING  
SLIDE SYSTEM

iMOVE

UNDERMOUNT SLIDE SYSTEM

iTRAX

GAS PISTON

iLIFT

DRAWER SYSTEM

iBOX

CORNER SOLUTIONS

iWAVE

WASTE BIN

iBIN

PANTRY UNIT

iTU

CUTLERY TRAY/GTPT

iFORM

BOTTLE PULLOUT

iBOX



**dorsët**  
we understand



## HINGE SYSTEM







iGen Soft Close Hinge comes with advanced soft close mechanism ensuring silent closing of doors along with high end design and functionality.



iGen Soft Close Hinge is designed with advanced technology and produced using a fully automated robotic production system together with new Generation Methods.





| Slide On Hinge   |   | Code         | Description                                 | Unit | MRP   | Package Content |
|--|---|--------------|---|------|-------|-----------------|
|  |  | <b>IG0C</b>  | Slide on Hinge 0 crank with mounting plate  | Pair | 88.00 | 50 Set          |
|  |   | <b>IG9C</b>  | Slide on Hinge 9 crank with mounting plate  | Pair | 93.00 | 50 Set          |
|  |   | <b>IG18C</b> | Slide on Hinge 18 crank with mounting plate | Pair | 98.00 | 50 Set          |

| Soft Close Slide On Hinge  |   | Code             | Description   | Unit | MRP    | Package Content |
|--|---|------------------|---|------|--------|-----------------|
|  |  | <b>IGSOSC0C</b>  | Soft Close Slide On Hinge 0 crank with 4 Hole mounting plate  | Pair | 188.00 | 50 Set          |
|  |   | <b>IGSOSC9C</b>  | Soft Close Slide On Hinge 9 crank with 4 Hole mounting plate  | Pair | 198.00 | 50 Set          |
|  |   | <b>IGSOSC18C</b> | Soft Close Slide On Hinge 18 crank with 4 Hole mounting plate | Pair | 204.00 | 50 Set          |

| Soft Close Hinge with 4 Hole Mounting Plate                                       |  | Code           | Description  | Unit | MRP    | Package Content |
|---|--|----------------|--|------|--------|-----------------|
|  |  | <b>IGSC0C</b>  | Soft Close Clip On Hinge 0 crank with 4 Hole mounting plate  | Pair | 265.00 | 50 Set          |
|   |  | <b>IGSC9C</b>  | Soft Close Clip On Hinge 9 crank with 4 Hole mounting plate  | Pair | 279.00 | 50 Set          |
|   |  | <b>IGSC18C</b> | Soft Close Clip On Hinge 18 crank with 4 Hole mounting plate | Pair | 293.00 | 50 Set          |

| Soft Close 3D Adjustable Hinge   |   | Code             | Description  | Unit | MRP    | Package Content |
|--|---|------------------|--|------|--------|-----------------|
|  |  | <b>IGSC3D0C</b>  | Soft Close Clip On Hinge 0 crank with 3D mounting plate  | Pair | 350.00 | 50 Set          |
|  |   | <b>IGSC3D9C</b>  | Soft Close Clip On Hinge 9 crank with 3D mounting plate  | Pair | 372.00 | 50 Set          |
|  |   | <b>IGSC3D18C</b> | Soft Close Clip On Hinge 18 crank with 3D mounting plate | Pair | 395.00 | 50 Set          |

| Soft Close SS 304 Hinge  |   | Code             | Description  | Unit | MRP    | Package Content |
|--|---|------------------|--|------|--------|-----------------|
|  |  | <b>IGSCSS0C</b>  | Soft Close Clip On Hinge 0 crank SS 304 Hinge with mounting plate  | Pair | 496.00 | 50 Set          |
|  |   | <b>IGSCSS9C</b>  | Soft Close Clip On Hinge 9 crank SS 304 Hinge with mounting plate  | Pair | 520.00 | 50 Set          |
|  |   | <b>IGSCSS18C</b> | Soft Close Clip On Hinge 18 crank SS 304 Hinge with mounting plate | Pair | 547.00 | 50 Set          |

**3D  
HINGE**



| Blind Corner 90° Hinge |   | Code        | Description   | Unit | MRP    | Package Content |
|------------------------|---|-------------|---|------|--------|-----------------|
| GEN                    |  | IGBLDCR90   | Blind Corner 90 Degree Hinge with Mounting Plate            | Pair | 408.00 | 30 Set          |
|                        |   | IGBLDCRSC90 | Blind Corner 90 Degree Soft Close Hinge with Mounting Plate | Pair | 817.00 | 30 Set          |

| Pi Corner 165° Hinge |   | Code        | Description   | Unit | MRP     | Package Content |
|----------------------|---|-------------|---|------|---------|-----------------|
| GEN                  |  | IGPICR165   | Pi Corner 165 Degree Hinge with Mounting Plate            | Pair | 592.00  | 30 Set          |
|                      |   | IGPICRSC165 | Pi Corner 165 Degree Soft Close Hinge with Mounting Plate | Pair | 1041.00 | 30 Set          |

| Bi-fold Hinge |  | Code  | Description                         | Unit | MRP    | Package Content |
|---------------|--|-------|-------------------------------------|------|--------|-----------------|
| GEN           |  | IGBFH | Bi - Fold Hinge with Mounting Plate | Pair | 572.00 | 30 Set          |

| Thick Door Hinge |   | Code    | Description                                   | Unit | MRP    | Package Content |
|------------------|---|---------|---|------|--------|-----------------|
| GEN              |  | IGTD0C  | Thick Door Hinge 0 Crank with Mounting Plate  | Pair | 260.00 | 30 Set          |
|                  |   | IGTD9C  | Thick Door Hinge 9 Crank with Mounting Plate  | Pair | 271.00 | 30 Set          |
|                  |   | IGTD18C | Thick Door Hinge 18 Crank with Mounting Plate | Pair | 281.00 | 30 Set          |

| Thick Door Soft Close Hinge |   | Code      | Description  | Unit | MRP    | Package Content |
|-----------------------------|---|-----------|--|------|--------|-----------------|
| GEN                         |  | IGSCTD0C  | Thick Door Soft Close Hinge 0 Crank with Mounting Plate  | Pair | 408.00 | 30 Set          |
|                             |   | IGSCTD9C  | Thick Door Soft Close Hinge 9 Crank with Mounting Plate  | Pair | 419.00 | 30 Set          |
|                             |   | IGSCTD18C | Thick Door Soft Close Hinge 18 Crank with Mounting Plate | Pair | 429.00 | 30 Set          |





SLIDE



BALL BEARING SLIDE SYSTEM

| Ball Bearing Full Extension Slide 46mm Zinc (45 Kg)                              |                | Code  | Description | Unit   | MRP    | Package Content |
|--|----------------|---|-------------|--------|--------|-----------------|
|  | <b>ISBB250</b> | I Slide Ball Bearing Slide Zinc 46 - 250 mm | Pair        | 364.00 | 10 Set |                 |
|  | <b>ISBB300</b> | I Slide Ball Bearing Slide Zinc 46 - 300 mm | Pair        | 393.00 | 10 Set |                 |
|  | <b>ISBB350</b> | I Slide Ball Bearing Slide Zinc 46 - 350 mm | Pair        | 432.00 | 10 Set |                 |
|  | <b>ISBB400</b> | I Slide Ball Bearing Slide Zinc 46 - 400 mm | Pair        | 454.00 | 10 Set |                 |
|  | <b>ISBB450</b> | I Slide Ball Bearing Slide Zinc 46 - 450 mm | Pair        | 500.00 | 10 Set |                 |
|  | <b>ISBB500</b> | I Slide Ball Bearing Slide Zinc 46 - 500 mm | Pair        | 517.00 | 10 Set |                 |
|  | <b>ISBB550</b> | I Slide Ball Bearing Slide Zinc 46 - 550 mm | Pair        | 570.00 | 10 Set |                 |
|  | <b>ISBB600</b> | I Slide Ball Bearing Slide Zinc 46 - 600 mm | Pair        | 610.00 | 10 Set |                 |

| Ball Bearing Full Extension Slide 46mm Black (45 Kg)                              |                  | Code   | Description | Unit   | MRP    | Package Content |
|---|------------------|--|-------------|--------|--------|-----------------|
|  | <b>ISBB250BL</b> | I Slide Ball Bearing Slide Black 46 - 250 mm | Pair        | 364.00 | 10 Set |                 |
|   | <b>ISBB300BL</b> | I Slide Ball Bearing Slide Black 46 - 300 mm | Pair        | 393.00 | 10 Set |                 |
|   | <b>ISBB350BL</b> | I Slide Ball Bearing Slide Black 46 - 350 mm | Pair        | 432.00 | 10 Set |                 |
|   | <b>ISBB400BL</b> | I Slide Ball Bearing Slide Black 46 - 400 mm | Pair        | 454.00 | 10 Set |                 |
|   | <b>ISBB450BL</b> | I Slide Ball Bearing Slide Black 46 - 450 mm | Pair        | 500.00 | 10 Set |                 |
|   | <b>ISBB500BL</b> | I Slide Ball Bearing Slide Black 46 - 500 mm | Pair        | 517.00 | 10 Set |                 |
|   | <b>ISBB550BL</b> | I Slide Ball Bearing Slide Black 46 - 550 mm | Pair        | 570.00 | 10 Set |                 |
|   | <b>ISBB600BL</b> | I Slide Ball Bearing Slide Black 46 - 600 mm | Pair        | 610.00 | 10 Set |                 |



| Ball Bearing Full Extension<br>Soft Close Slide 46mm Zinc (30 Kg)  |                  | Code  | Description | Unit    | MRP    | Package Content |
|--|------------------|---|-------------|---------|--------|-----------------|
|   | <b>IMBB300SC</b> | I Move Soft close Ball Bearing Slide Zinc 46 - 300 mm | Pair        | 858.00  | 10 Set |                 |
|  | <b>IMBB350SC</b> | I Move Soft close Ball Bearing Slide Zinc 46 - 350 mm | Pair        | 879.00  | 10 Set |                 |
|  | <b>IMBB400SC</b> | I Move Soft close Ball Bearing Slide Zinc 46 - 400 mm | Pair        | 902.00  | 10 Set |                 |
|  | <b>IMBB450SC</b> | I Move Soft close Ball Bearing Slide Zinc 46 - 450 mm | Pair        | 930.00  | 10 Set |                 |
|  | <b>IMBB500SC</b> | I Move Soft close Ball Bearing Slide Zinc 46 - 500 mm | Pair        | 956.00  | 10 Set |                 |
|  | <b>IMBB550SC</b> | I Move Soft close Ball Bearing Slide Zinc 46 - 550 mm | Pair        | 988.00  | 10 Set |                 |
|  | <b>IMBB600SC</b> | I Move Soft close Ball Bearing Slide Zinc 46 - 600 mm | Pair        | 1140.00 | 10 Set |                 |

| Ball Bearing Full Extension<br>Soft Close Slide 46mm Black (30 Kg)   |                    | Code   | Description | Unit    | MRP    | Package Content |
|--|--------------------|--|-------------|---------|--------|-----------------|
|   | <b>IMBB300SCBL</b> | I Move Soft close Ball Bearing Slide Black 46 - 300 mm | Pair        | 858.00  | 10 Set |                 |
|  | <b>IMBB350SCBL</b> | I Move Soft close Ball Bearing Slide Black 46 - 350 mm | Pair        | 879.00  | 10 Set |                 |
|  | <b>IMBB400SCBL</b> | I Move Soft close Ball Bearing Slide Black 46 - 400 mm | Pair        | 902.00  | 10 Set |                 |
|  | <b>IMBB450SCBL</b> | I Move Soft close Ball Bearing Slide Black 46 - 450 mm | Pair        | 930.00  | 10 Set |                 |
|  | <b>IMBB500SCBL</b> | I Move Soft close Ball Bearing Slide Black 46 - 500 mm | Pair        | 956.00  | 10 Set |                 |
|  | <b>IMBB550SCBL</b> | I Move Soft close Ball Bearing Slide Black 46 - 550 mm | Pair        | 988.00  | 10 Set |                 |
|  | <b>IMBB600SCBL</b> | I Move Soft close Ball Bearing Slide Black 46 - 600 mm | Pair        | 1140.00 | 10 Set |                 |







UNDER MOUNT SLIDE SYSTEM

**dorsët**  
we understand



| Undermount Slide System W 40Kg   |                 | Code                           | Description | Unit    | MRP   | Package Content |
|--|-----------------|--------------------------------|-------------|---------|-------|-----------------|
|   | <b>ITRAX300</b> | I Trax Undermount Slide 300 mm | Pair        | 1869.00 | 6 Set |                 |
|  | <b>ITRAX350</b> | I Trax Undermount Slide 350 mm | Pair        | 1869.00 | 6 Set |                 |
|  | <b>ITRAX400</b> | I Trax Undermount Slide 400 mm | Pair        | 1869.00 | 6 Set |                 |
|  | <b>ITRAX450</b> | I Trax Undermount Slide 450 mm | Pair        | 1930.00 | 6 Set |                 |
|  | <b>ITRAX500</b> | I Trax Undermount Slide 500 mm | Pair        | 2032.00 | 6 Set |                 |
|  | <b>ITRAX550</b> | I Trax Undermount Slide 550 mm | Pair        | 2235.00 | 6 Set |                 |





| Gas Piston   |               | Code                    | Description | Unit   | MRP    | Package Content |
|--|---------------|-------------------------|-------------|--------|--------|-----------------|
|   | <b>IL60N</b>  | Gas piston Lift up 60N  | Pair        | 285.00 | 25 Set |                 |
|  | <b>IL80N</b>  | Gas piston Lift up 80N  | Pair        | 285.00 | 25 Set |                 |
|  | <b>IL100N</b> | Gas piston Lift up 100N | Pair        | 285.00 | 25 Set |                 |
|  | <b>IL120N</b> | Gas piston Lift up 120N | Pair        | 285.00 | 25 Set |                 |
|  | <b>IL150N</b> | Gas piston Lift up 150N | Pair        | 285.00 | 25 Set |                 |
|  | <b>IL200N</b> | Gas piston Lift up 200N | Pair        | 310.00 | 25 Set |                 |
|  | <b>IL250N</b> | Gas piston Lift up 250N | Pair        | 310.00 | 25 Set |                 |



**BOX**  
DRAWER SYSTEM



**dorsët**  
we understand









| Drawer System<br>H 89mm : W 40Kg |  | Code               | Description                          | Unit | MRP     | Package Content |
|----------------------------------|--|--------------------|--------------------------------------|------|---------|-----------------|
| iBOX                             |   | <b>IBOX350GR89</b> | I Box 350 mm Grey Height 89 mm       | Set  | 3150.00 | 4 Set           |
|                                  |  | <b>IBOX400GR89</b> | I Box 400 mm Grey Height 89 mm       | Set  | 3150.00 | 4 Set           |
|                                  |  | <b>IBOX450GR89</b> | I Box 450 mm Grey Height 89 mm       | Set  | 3150.00 | 4 Set           |
|                                  |  | <b>IBOX500GR89</b> | I Box 500 mm Grey Height 89 mm       | Set  | 3150.00 | 4 Set           |
|                                  |  | <b>IBOX550GR89</b> | I Box 550 mm Grey Height 89 mm       | Set  | 3150.00 | 4 Set           |
|                                  |   | <b>IBOX350AN89</b> | I Box 350 mm Anthracite Height 89 mm | Set  | 3150.00 | 4 Set           |
|                                  |  | <b>IBOX400AN89</b> | I Box 400 mm Anthracite Height 89 mm | Set  | 3150.00 | 4 Set           |
|                                  |  | <b>IBOX450AN89</b> | I Box 450 mm Anthracite Height 89 mm | Set  | 3150.00 | 4 Set           |
|                                  |  | <b>IBOX500AN89</b> | I Box 500 mm Anthracite Height 89 mm | Set  | 3150.00 | 4 Set           |
|                                  |  | <b>IBOX550AN89</b> | I Box 550 mm Anthracite Height 89 mm | Set  | 3150.00 | 4 Set           |
|                                  |  | <b>IBOX350MO89</b> | I Box 350 mm Mocha Height 89 mm      | Set  | 3203.00 | 4 Set           |
|                                  |  | <b>IBOX400MO89</b> | I Box 400 mm Mocha Height 89 mm      | Set  | 3203.00 | 4 Set           |
|                                  |  | <b>IBOX450MO89</b> | I Box 450 mm Mocha Height 89 mm      | Set  | 3203.00 | 4 Set           |
|                                  |  | <b>IBOX500MO89</b> | I Box 500 mm Mocha Height 89 mm      | Set  | 3203.00 | 4 Set           |
|                                  |  | <b>IBOX550MO89</b> | I Box 550 mm Mocha Height 89 mm      | Set  | 3203.00 | 4 Set           |

| Drawer System<br>H 127mm : W 40Kg |   | Code                | Description                           | Unit | MRP     | Package Content |
|-----------------------------------|---|---------------------|---------------------------------------|------|---------|-----------------|
| iBOX                              |  | <b>IBOX400GR127</b> | I Box 400 mm Grey Height 127 mm       | Set  | 3704.00 | 4 Set           |
|                                   |   | <b>IBOX450GR127</b> | I Box 450 mm Grey Height 127 mm       | Set  | 3704.00 | 4 Set           |
|                                   |   | <b>IBOX500GR127</b> | I Box 500 mm Grey Height 127 mm       | Set  | 3704.00 | 4 Set           |
|                                   |   | <b>IBOX550GR127</b> | I Box 550 mm Grey Height 127 mm       | Set  | 3704.00 | 4 Set           |
|                                   |  | <b>IBOX400AN127</b> | I Box 400 mm Anthracite Height 127 mm | Set  | 3704.00 | 4 Set           |
|                                   |   | <b>IBOX450AN127</b> | I Box 450 mm Anthracite Height 127 mm | Set  | 3704.00 | 4 Set           |
|                                   |   | <b>IBOX500AN127</b> | I Box 500 mm Anthracite Height 127 mm | Set  | 3704.00 | 4 Set           |
|                                   |   | <b>IBOX550AN127</b> | I Box 550 mm Anthracite Height 127 mm | Set  | 3704.00 | 4 Set           |
|                                   |  | <b>IBOX400MO127</b> | I Box 400 mm Mocha Height 127 mm      | Set  | 3804.00 | 4 Set           |
|                                   |   | <b>IBOX450MO127</b> | I Box 450 mm Mocha Height 127 mm      | Set  | 3804.00 | 4 Set           |
|                                   |   | <b>IBOX500MO127</b> | I Box 500 mm Mocha Height 127 mm      | Set  | 3804.00 | 4 Set           |
|                                   |   | <b>IBOX550MO127</b> | I Box 550 mm Mocha Height 127 mm      | Set  | 3804.00 | 4 Set           |



| Drawer System<br>H 174mm : W 40Kg |   | Code                | Description                           | Unit | MRP     | Package Content |
|-----------------------------------|---|---------------------|---------------------------------------|------|---------|-----------------|
| i BOX                             |  | <b>IBOX400GR174</b> | I Box 400 mm Grey Height 174 mm       | Set  | 4304.00 | 4 Set           |
|                                   |   | <b>IBOX450GR174</b> | I Box 450 mm Grey Height 174 mm       | Set  | 4304.00 | 4 Set           |
|                                   |   | <b>IBOX500GR174</b> | I Box 500 mm Grey Height 174 mm       | Set  | 4304.00 | 4 Set           |
|                                   |   | <b>IBOX550GR174</b> | I Box 550 mm Grey Height 174 mm       | Set  | 4304.00 | 4 Set           |
|                                   |  | <b>IBOX400AN174</b> | I Box 400 mm Anthracite Height 174 mm | Set  | 4304.00 | 4 Set           |
|                                   |   | <b>IBOX450AN174</b> | I Box 450 mm Anthracite Height 174 mm | Set  | 4304.00 | 4 Set           |
|                                   |   | <b>IBOX500AN174</b> | I Box 500 mm Anthracite Height 174 mm | Set  | 4304.00 | 4 Set           |
|                                   |   | <b>IBOX550AN174</b> | I Box 550 mm Anthracite Height 174 mm | Set  | 4304.00 | 4 Set           |
|                                   |  | <b>IBOX400MO174</b> | I Box 400 mm Mocha Height 174 mm      | Set  | 4404.00 | 4 Set           |
|                                   |   | <b>IBOX450MO174</b> | I Box 450 mm Mocha Height 174 mm      | Set  | 4404.00 | 4 Set           |
|                                   |   | <b>IBOX500MO174</b> | I Box 500 mm Mocha Height 174 mm      | Set  | 4404.00 | 4 Set           |
|                                   |   | <b>IBOX550MO174</b> | I Box 550 mm Mocha Height 174 mm      | Set  | 4404.00 | 4 Set           |

| Drawer System<br>H 206mm : W 40Kg |   | Code                | Description                           | Unit | MRP     | Package Content |
|-----------------------------------|---|---------------------|---------------------------------------|------|---------|-----------------|
| i BOX                             |  | <b>IBOX400GR206</b> | I Box 400 mm Grey Height 206 mm       | Set  | 4755.00 | 4 Set           |
|                                   |   | <b>IBOX450GR206</b> | I Box 450 mm Grey Height 206 mm       | Set  | 4755.00 | 4 Set           |
|                                   |   | <b>IBOX500GR206</b> | I Box 500 mm Grey Height 206 mm       | Set  | 4755.00 | 4 Set           |
|                                   |   | <b>IBOX550GR206</b> | I Box 550 mm Grey Height 206 mm       | Set  | 4755.00 | 4 Set           |
|                                   |  | <b>IBOX400AN206</b> | I Box 400 mm Anthracite Height 206 mm | Set  | 4755.00 | 4 Set           |
|                                   |   | <b>IBOX450AN206</b> | I Box 450 mm Anthracite Height 206 mm | Set  | 4755.00 | 4 Set           |
|                                   |   | <b>IBOX500AN206</b> | I Box 500 mm Anthracite Height 206 mm | Set  | 4755.00 | 4 Set           |
|                                   |   | <b>IBOX550AN206</b> | I Box 550 mm Anthracite Height 206 mm | Set  | 4755.00 | 4 Set           |
|                                   |  | <b>IBOX400MO206</b> | I Box 400 mm Mocha Height 206 mm      | Set  | 4855.00 | 4 Set           |
|                                   |   | <b>IBOX450MO206</b> | I Box 450 mm Mocha Height 206 mm      | Set  | 4855.00 | 4 Set           |
|                                   |   | <b>IBOX500MO206</b> | I Box 500 mm Mocha Height 206 mm      | Set  | 4855.00 | 4 Set           |
|                                   |   | <b>IBOX550MO206</b> | I Box 550 mm Mocha Height 206 mm      | Set  | 4855.00 | 4 Set           |

| Gallery Railing   |                     | Code                                    | Description | Unit   | MRP    | Package Content |
|---|---------------------|---|-------------|--------|--------|-----------------|
|  <p><b>1 BOX</b></p> | <b>IBOXGLYGR400</b> | I Box Gallery Railing Grey 400 mm       | Set         | 601.00 | 20 Set |                 |
|   | <b>IBOXGLYGR450</b> | I Box Gallery Railing Grey 450 mm       | Set         | 601.00 | 20 Set |                 |
|   | <b>IBOXGLYGR500</b> | I Box Gallery Railing Grey 500 mm       | Set         | 601.00 | 20 Set |                 |
|   | <b>IBOXGLYGR550</b> | I Box Gallery Railing Grey 550 mm       | Set         | 601.00 | 20 Set |                 |
|   | <b>IBOXGLYAN400</b> | I Box Gallery Railing Anthracite 400 mm | Set         | 601.00 | 20 Set |                 |
|   | <b>IBOXGLYAN450</b> | I Box Gallery Railing Anthracite 450 mm | Set         | 601.00 | 20 Set |                 |
|   | <b>IBOXGLYAN500</b> | I Box Gallery Railing Anthracite 500 mm | Set         | 601.00 | 20 Set |                 |
|   | <b>IBOXGLYAN550</b> | I Box Gallery Railing Anthracite 550 mm | Set         | 601.00 | 20 Set |                 |
|   | <b>IBOXGLYMO400</b> | I Box Gallery Railing Mocha 400 mm      | Set         | 651.00 | 20 Set |                 |
|   | <b>IBOXGLYMO450</b> | I Box Gallery Railing Mocha 450 mm      | Set         | 651.00 | 20 Set |                 |
|   | <b>IBOXGLYMO500</b> | I Box Gallery Railing Mocha 500 mm      | Set         | 651.00 | 20 Set |                 |
|   | <b>IBOXGLYMO550</b> | I Box Gallery Railing Mocha 550 mm      | Set         | 651.00 | 20 Set |                 |



# KITCHEN HARDWARE



| <b>WAVE</b>                |   | <b>Code</b>         | <b>Description</b>                                  | <b>Unit</b> | <b>MRP</b> | <b>Package Content</b> |
|----------------------------|---|---------------------|---|-------------|------------|------------------------|
| <b>SWING TRAY</b>          |  | <b>IWAVESTL</b>     | I Wave Swing Tray Left                              | Set         | 21,252     | Set                    |
|                            |   | <b>IWAVESTR</b>     | I Wave Swing Tray Right                             | Set         | 21,252     | Set                    |
| <b>MAGIC CORNER</b>        |  | <b>IWAVEMCFLR12</b> | I Wave Magic Corner Frame Universal Left-Right Box  | Set         | 19,764     | Set                    |
|                            |   | <b>IWAVEMCBLR22</b> | I Wave Magic Corner Basket Universal Left-Right Box | Set         | 10,642     | Set                    |
| <b>3/4 CORNER CAROUSEL</b> |  | <b>IWAVECC</b>      | I Wave 3/4 Corner Carousel                          | Set         | 9,470      | Set                    |

| <b>TU</b>                     |   | <b>Code</b>        | <b>Description</b>                                  | <b>Unit</b> | <b>MRP</b> | <b>Package Content</b> |
|-------------------------------|---|--------------------|---|-------------|------------|------------------------|
| <b>PULL OUT LADDER PANTRY</b> |  | <b>ITUPOLPF13</b>  | I Tu Pantry Pull Out Ladder Fram Box (1/3)          | Set         | 15,309     | Set                    |
|                               |   | <b>ITUPOLPBR23</b> | I Tu Pantry Pull Out Ladder Bottom Runner Box (2/3) | Set         | 4,593      | Set                    |
|                               |   | <b>ITUPOLPB33</b>  | I Tu Pantry Pull Out Ladder Basket Box (3/3)        | Set         | 10,716     | Set                    |
| <b>PANTRY DUO</b>             |  | <b>ITUPD450F12</b> | I Tu Pantry Duo 450mm Frame Box (1/2)               | Set         | 21,132     | Set                    |
|                               |   | <b>ITUPD450B22</b> | I Tu Pantry Duo 450mm Basket 6+6 Box (2/2)          | Set         | 11,379     | Set                    |
|                               |   | <b>ITUPD600F12</b> | I Tu Pantry Duo 600mm Frame Box (1/2)               | Set         | 24,962     | Set                    |
|                               |   | <b>ITUPD600B22</b> | I Tu Pantry Duo 600mm Basket 6+6 Box (2/2)          | Set         | 13,441     | Set                    |

| <b>BIN</b>       |   | <b>Code</b>    | <b>Description</b>                     | <b>Unit</b> | <b>MRP</b> | <b>Package Content</b> |
|------------------|---|----------------|--|-------------|------------|------------------------|
| <b>WASTE BIN</b> |  | <b>IBIN14L</b> | I Bin SS With Plastic Waste Bin 14 LTR | Set         | 3,260      | Set                    |

| FORM                  |   | Code            | Description                   | Unit | MRP   | Package Content |
|-----------------------|---|-----------------|-------------------------------|------|-------|-----------------|
| CUTLERY TRAY          |  | <b>ICT450</b>   | I Form Cutlery Tray 450mm     | Set  | 633   | Set             |
|                       |   | <b>ICT500</b>   | I Form Cutlery Tray 500mm     | Set  | 690   | Set             |
|                       |   | <b>ICT600</b>   | I Form Cutlery Tray 600mm     | Set  | 816   | Set             |
|                       |   | <b>ICT900</b>   | I Form Cutlery Tray 900mm     | Set  | 1,576 | Set             |
| GLASS TRAY PLATE TRAY |  | <b>IGTPT600</b> | I Form Glass Tray Plate 600mm | Set  | 3,786 | Set             |
|                       |   | <b>IGTPT900</b> | I Form Glass Tray Plate 900mm | Set  | 5,482 | Set             |

| BOX             |  | Code                | Description                            | Unit | MRP   | Package Content |
|-----------------|--|---------------------|--|------|-------|-----------------|
| BOTTLE PULL OUT |  | <b>IBOXBPO500GR</b> | I Box Bottle Pull Out Grey 500mm       | Set  | 7,000 | Set             |
|                 |  | <b>IBOXBPO500AN</b> | I Box Bottle Pull Out Anthracite 500mm | Set  | 7,000 | Set             |
|                 |  | <b>IBOXBPO500MO</b> | I Box Bottle Pull Out Mocha 500mm      | Set  | 7,000 | Set             |

| Stainless Steel Pull Handles (SS Grade-304) |   | Finish Available |            |            |            |
|---|---|------------------|------------|------------|------------|
|   |   | SS               |            |            |            |
| Primo (Pair)                                | <br>Size<br>180mm<br>230mm<br>282mm<br>330mm<br>Fire Rated Upto 2 Hours | PR 06 P SS       | PR 08 P SS | PR 10 P SS | PR 12 P SS |
|   |   | 2040             | 2165       | 2355       | 2545       |
| Eden (Pair)                                 | <br>Size<br>184mm<br>234mm<br>286mm<br>334mm<br>Fire Rated Upto 2 Hours | ED 06 P SS       | ED 08 P SS | ED 10 P SS | ED 12 P SS |
|   |   | 1470             | 1620       | 1740       | 1905       |



| Stainless Steel Pull Handles (SS Grade-304) |                             | 19mm dia |         | 22mm dia   |         |          |         |  |
|---|-----------------------------|----------|---------|------------|---------|----------|---------|--|
|   |                             | SS       |         | SS         |         |          |         |  |
| D Type (Pair)                               | <br>Fire Rated Upto 2 Hours | 150mm    | SD06PSS |            | SD06PSS |          |         |  |
|   |                             |          | 1385    |            | 1470    |          |         |  |
|   |                             | 200mm    | SD08PSS |            | SD08PSS |          |         |  |
|   |                             |          | 1545    |            | 1620    |          |         |  |
|   |                             | 250mm    | SD10PSS |            | SD10PSS |          |         |  |
|   |                             |          | 1670    |            | 1755    |          |         |  |
|   |                             | 300mm    | SD12PSS |            | SD12PSS |          |         |  |
|   |                             |          | 1830    |            | 1905    |          |         |  |
|   |                             | 400mm    |         | 25.4mm dia |         | 32mm dia |         |  |
|   |                             |          |         | SS         |         | SS       |         |  |
|   |                             |          |         | 400mm      | SD16PSS |          | SD24PSS |  |
|   |                             |          |         |            | 2910    |          | 4050    |  |
| 450mm                                       | SD18PSS                     |          |         | SD30PSS    |         |          |         |  |
|   | 3130                        |          |         | 4860       |         |          |         |  |
| 500mm                                       | SD20PSS                     |          |         | SD36PSS    |         |          |         |  |
|   | 3360                        |          |         | 5655       |         |          |         |  |
| 600mm                                       |                             |          |         | SD48PSS    |         |          |         |  |
|   |                             |          |         | 7380       |         |          |         |  |

| Stainless Steel Pull Handles (SS Grade-304) |                             | 22mm dia |            |  |
|---|-----------------------------|----------|------------|--|
|   |                             | SS       |            |  |
| SEP Type (Pair)                             | <br>Fire Rated Upto 2 Hours | 200mm    | SEP 08 PSS |  |
|   |                             |          | 1620       |  |
|   |                             | 250mm    | SEP 10 PSS |  |
|   |                             |          | 1790       |  |
| 300mm                                       | SEP 12 PSS                  |          |            |  |
|   | 1960                        |          |            |  |

| Stainless Steel Pull Handles (SS Grade-304) |                             | 22mm dia | 25.4mm dia | 32mm dia |            |
|---|-----------------------------|----------|------------|----------|------------|
|   |                             | SS       | SS         | SS       |            |
| H Type (Pair)                               | <br>Fire Rated Upto 2 Hours | 200mm    | SH 08 P SS |          |            |
|   |                             |          | 2165       |          |            |
|   |                             | 250mm    | SH 10 P SS |          |            |
|   |                             |          | 2370       |          |            |
|   |                             | 300mm    | SH 12 P SS |          |            |
|   |                             |          | 2545       |          |            |
|   |                             | 350mm    |            |          | SH 14 P SS |
|   |                             |          |            |          | 3115       |
|   |                             | 400mm    |            |          | SH 16 P SS |
|   |                             |          |            |          | 3360       |
|   |                             | 450mm    |            |          | SH 18 P SS |
|   |                             |          |            |          | 3595       |
| 600mm                                       |                             |          | SH 24 P SS |          |            |
|   |                             |          | 4830       |          |            |
| 750mm                                       |                             |          | SH 30 P SS |          |            |
|   |                             |          | 5525       |          |            |
| 900mm                                       |                             |          | SH 36 P SS |          |            |
|   |                             |          | 6230       |          |            |
| 1200mm                                      |                             |          | SH 48 P SS |          |            |
|   |                             |          | 7635       |          |            |

| Mortise Lock |                             |  |  |                  |      |           |
|--------------|-----------------------------|--|--|------------------|------|-----------|
|              |                             |  | Description                                | Finish Available |      | Std. Pkg. |
|              |                             |  |  | SS               |      |           |
| ML 100       | <br>Fire Rated Upto 2 Hours |  | Mortise Sash Lock-Fire Rated 50mm Backset  | ML 100 SS (FR)   | 1895 | 20        |
|              |                             |  | Mortise Sash Lock-Fire Rated 55mm Backset  | ML 101 SS (FR)   |      |           |
| ML 100L      | <br>Fire Rated Upto 2 Hours |  | Mortise Latch Lock-Fire Rated 50mm Backset | ML 100L SS (FR)  | 1700 | 20        |
|              |                             |  | Mortise Latch Lock-Fire Rated 55mm Backset | ML 101L SS (FR)  |      |           |
| ML 100D      | <br>Fire Rated Upto 2 Hours |  | Mortise Dead Lock-Fire Rated 50mm Backset  | ML 100D SS (FR)  | 1700 | 20        |
|              |                             |  | Mortise Dead Lock-Fire Rated 55mm Backset  | ML 101D SS (FR)  |      |           |

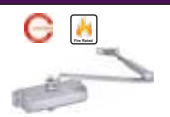





| Mortise Lock   |  |                  |      |           |  |
|--|--|------------------|------|-----------|--|
|  | Description                                      | Finish Available |      | Std. Pkg. |  |
|  |  | SS               |      |           |  |
|  <br><b>ML 103L</b> <br><small>Fire Rated Upto 2 Hours</small> | <b>Mortise Sash Lock-Fire Rated 55mm Backset</b> | ML 103L SS (FR)  | 1480 | 20        |  |
| <br><b>ML 103D</b><br><small>Fire Rated Upto 2 Hours</small>  | <b>Mortise Sash Lock-Fire Rated 55mm Backset</b> | ML 103D SS (FR)  | 1480 | 20        |  |

| Door Closers |   | Description | Weight | Finish | Std. Pkg. |
|--------------|---|-------------|--------|--------|-----------|
|              |   |             |        | SS     |           |
| FR 60        | <br><small>Fire Rated Upto 2 Hours</small>  | Door Closer | 60 Kg  | 2555   | 10        |
| FR 80        | <br><small>Fire Rated Upto 2 Hours</small> | Door Closer | 80 Kg  | 3220   | 10        |
| FR 120       | <br><small>Fire Rated Upto 2 Hours</small> | Door Closer | 120 Kg | 6380   | 10        |







|   | SS 2 Ball Bearing Hinges (with screw) | Size             | Code      | Finish | Std. Pkg. |
|---|---------------------------------------|------------------|-----------|--------|-----------|
|   |                                       |                  |           | SS     |           |
| <br><small>Fire Rated Upto 2 Hours</small> |                                       | 102 X 76 X 2.5MM | HG 1151 A | 355    | 40        |
|   |                                       | 127 X 76 X 2.5MM | HG 1152 A | 390    | 40        |
|   |                                       | 102 X 76 X 3MM   | HG 1153 A | 400    | 40        |
|   |                                       | 127 X 76 X 3MM   | HG 1154 A | 480    | 40        |





|   | SS 2 Ball Bearing Hinges (with screw) | Size       | Code    | Finish | Std. Pkg. |
|---|---------------------------------------|------------|---------|--------|-----------|
|   |                                       |            |         | SS     |           |
| <br><small>Fire Rated Upto 2 Hours</small> |                                       | 102x76x3mm | HG 1253 | 620    | 40        |

|  | SS 2 Ball Bearing Hinges (with screw) | Size             | Code       | Finish | Std. Pkg. |
|--|---------------------------------------|------------------|------------|--------|-----------|
|  |                                       |                  |            | SS     |           |
| <br><small>Fire Rated Upto 2 Hours</small> |                                       | 127 X 76 X 2.5MM | HGRC1152 A | 590    | 40        |
|  |                                       | 102 X 76 X 3MM   | HGRC1153 A | 550    | 40        |

| Solid Stainless Steel (SS304)   |           | 19mm dia  |
|---|-----------|-----------|
|   |           | SS        |
| <br><b>Orius</b>    |           | ORS OR SS |
|   |           | 3990      |
| <br><b>Cella</b>    |           | CLA OR SS |
|   |           | 3745      |
| <br><b>Merina</b> |           | MER OR SS |
|   |           | 3300      |
| <br><b>Axor</b>   |           | AXO OR SS |
|   |           | 3300      |
| <br><b>Eden</b>   |           | ED OR SS  |
|   | Size 54mm | 1790      |
| <br><b>Primo</b>  |           | PR OR SS  |
|   | Size 54mm | 1945      |























| Solid Stainless Steel (SS304)<br> |           | 19mm dia | 22mm dia |
|--|-----------|----------|----------|
|  |           | SS       | SS       |
| D Type<br><br>Size 50mm           | SD OR SS  | SD OR SS |          |
|  | 1605      | 1670     |          |
| SLP<br><br>Size 50.4mm            | SLP OR SS |          |          |
|  | 1605      |          |          |
| L Type<br><br>Size 50.4mm         | SL OR SS  | SL OR SS |          |
|  | 1605      | 1670     |          |
| C Type<br><br>Size 51mm          |           | SC OR SS |          |
|  |           | 2080     |          |
| SEP<br><br>Size 50.4mm          | SEP OR SS |          |          |
|  | 1605      |          |          |

| Panic Bar<br>            |           | Door Height: 2200mm | Door Height: 2400mm |
|--|-----------|---------------------|---------------------|
|  |           | NS                  | NS                  |
| Single Point Locking<br> | PB-1P00NS |                     |                     |
|  | 4990      |                     |                     |
| Two Point Locking<br>    | PB-2P22NS | PB-2P24NS           |                     |
|  | 9000      | 9700                |                     |
| Three Point Locking<br>  | PB-3P22NS | PB-3P24NS           |                     |
|  | 10200     | 11070               |                     |
| External Trim<br>       | PB-ET01NS |                     |                     |
|  | 4660      |                     |                     |



abitare  
Door Handles

ABITARE SERIES - DESIGNED IN ITALY  
(BRASS)

|       | Finish Available   |   |  |  |  |
|-------|--|---|--|--|--|
|       | PT   | SN/TM   | FE/HG  | TM/MR  | GM/VG  |
| Leva  | <br>LEV OR PT   | <br>LEV OR SN    | <br>LEV OR FE   | <br>LEV OR TM   |  |
|       | 4675   | 4905  | 5375   | 4950   |  |
| Torsa | <br>TOR OR PT   | <br>TOR OR SN/TM | <br>TOR OR FE   | <br>TOR OR MR   | <br>TOR OR VG |
|       | 4440   | 4910  | 5400   | 4675   | 5140   |
| Globo | <br>GLO OR PT   | <br>GLO OR SN    | <br>GLO OR FE   |  | <br>GLO OR GM |
|       | 4440   | 5155  | 5645   |  | 5200   |
| Twirl | <br>TWR OR PT | <br>TWR OR SN  | <br>TWR OR HG | <br>TWR OR TM |  |
|       | 4440   | 5155  | 5645   | 5155   |  |
| Deco  | <br>DEC OR PT | <br>DEC OR SN  |  | <br>DEC OR TM |  |
|       | 4440   | 5155  |  | 5155   |  |













| Farretto<br><i>Colours</i><br>(Brass) Door Handles |   | Finish Available |            |            |            |
|--|---|------------------|------------|------------|------------|
|  |   | FETM             | GMHG       | HGGM       | TMHG       |
| Juliet   |  | JL OR FETM       | JL OR GMHG | JL OR HGGM | JL OR TMHG |
|  |   | 4830             | 4445       | 4830       | 4445       |

| Farretto<br><i>Colours</i><br>(Brass) Door Handles |   | Finish Available |              |           |                 |           |
|--|---|------------------|--------------|-----------|-----------------|-----------|
|  |   | SN               | HG/FG        | FE/GM     | GM/MR/CB        | TM/VG     |
| Cadilla  |    |                  | CAD OR HG    | CAD OR GM | CAD OR CB/MR    | CAD OR VG |
|  |   |                  | 4620         | 4145      | 4090            | 4620      |
| Roccia   |    |                  | ROC OR HG    |           | ROC OR GM/MR/CB | ROC OR VG |
|  |   |                  | 5840         |           | 5155            | 5840      |
| Madonna  |    | MA OR SN         | MA OR HG     |           |                 | MA OR TM  |
|  |   | 4305             | 4975         |           |                 | 4305      |
| Blob   |    |                  | BB OR HG     | BB OR FE  | BB OR GM        |           |
|  |   |                  | 5435         | 5435      | 5435            |           |
| Dana   |   | DA OR SN         | DA OR HG     | DA OR FE  |                 |           |
|  |   | 4045             | 4445         | 4445      |                 |           |
| Vanya  |  | VNY OR SN        | VNY OR FG    | VNY OR FE | VNY OR GM       |           |
|  |   | 4800             | 5400         | 5400      | 4800            |           |
| Anika  |  | ANK OR SN        | ANK OR FG/HG |           |                 | ANK OR TM |
|  |   | 4700             | 5400         |           |                 | 4700      |

| Farretto<br><i>Colours</i><br>Door Handles |   | Finish Available |             |              |             |
|--|---|------------------|-------------|--------------|-------------|
| Riva                                       |  | RIV OR SN        | RIV OR HG   | RIV OR MR/CB | RIV OR NM   |
|  |   | 3190             | 3615        | 3190         | 3615        |
| Konica                                     |  |                  | KON OR FEGM | KON OR HGFE  |             |
|  |   |                  | 4680        | 4820         |             |
| Speera                                     |  | SPE OR GMHG      | SPE OR FEWD | SPE OR HGFE  | SPE OR TMWD |
|  |   | 3875             | 3875        | 4150         | 3615        |
| Orbia                                      |  |                  | OBI OR BNGM | OBI OR HGFE  |             |
|  |   |                  | 4750        | 5020         |             |
| Cornus                                     |  |                  | COR OR BNGM | COR OR HGFE  |             |
|  |   |                  | 4880        | 5155         |             |



| Farretto<br><i>Colours</i><br>Door Handles |  | Finish Available |                  |                |             |
|--|--|------------------|------------------|----------------|-------------|
| Pilot                                      |  | PIL OR GMHG      | PIL OR FEGM      | PIL OR HGFE    | PIL OR SNTM |
|  |  | 4820             | 4820             | 5085           | 4275        |
| Infinito                                   |  | INF OR GMHG      | INF OR FEGM      | INF OR HGFE    |             |
|  |  | 4425             | 4680             | 4955           |             |
| Trase                                      |  | TRA OR GMHG/TMHG | TRA OR FEGM/VGGM | TRA OR HGFE    | TRA OR CBMR |
|  |  | 4550             | 4680             | 4955           | 4550        |
| Flo  |  | FLL OR GMHG      | FLL OR FEWD      | FLL OR TMSN/MR | FLL OR NM   |
|  |  | 4150             | 4820             | 4020           | 4820        |



| Farretto<br><i>Colours</i><br>Door Handles |  | Finish Available |                 |                 |              |           |
|--|--|------------------|-----------------|-----------------|--------------|-----------|
|  |  | SN/TM            | GM/CT/FM        | HG/FE/VG        | CB/MR        | NM        |
| Polar                                      |   | POL OR SN/TM     |                 | POL OR HG       | POL OR CB    | POL OR NM |
|  |  | 3285             |                 | 3825            | 3285         | 3935      |
| Ryder                                      |  | RYD OR TM        |                 | RYD OR FE       | RYD OR CB/MR |           |
|  |  | 3615             |                 | 4150            | 3615         |           |
| Flap                                       |  | FLA OR TM        |                 | FLA OR FE       |              |           |
|  |  | 4020             |                 | 4955            |              |           |
| Celisa                                     |  | CLS OR SN/TM     | CLS OR GM/FM    | CLS OR HG/FE/VG |              | CLS OR NM |
|  |  | 4020             | 4215            | 4915            |              | 5020      |
| Drop                                       |  | DRP OR SN/TM     | DRP OR CT/FM    | DRP OR HG/FE    | DRP OR CB/MR |           |
|  |  | 3615             | 3720            | 4275            | 3615         |           |
| Reflex                                     |  | REF OR SN/TM     |                 | REF OR HG/FE    |              |           |
|  |  | 3615             |                 | 4275            |              |           |
| Volex                                      |  | VOE OR SN/TM     | VOE OR GM/CT/FM |                 |              |           |
|  |  | 3020             | 3145            |                 |              |           |
| Vitra                                      |  | VIT OR SN/TM     | VIT OR GM/CT/FM | VIT OR HG       |              |           |
|  |  | 2865             | 2995            | 3465            |              |           |
| Atelier                                    |  | ATL OR SN/TM     | ATL OR GM/CT/FM | ATL OR HG/VG    |              | ATL OR NM |
|  |  | 2865             | 2995            | 3465            |              | 3570      |











| Farretto<br>Collection<br>Door Handles |   | Finish Available |                 |           |       |    |
|--|---|------------------|-----------------|-----------|-------|----|
|  |   | SN/TM            | GM/CT/FM        | HG/FE/VG  | CB/MR | NM |
| Siera                                  |  | SIA OR SN/TM     | SIA OR GM/CT/FM | SIA OR HG |       |    |
|  |   | 3020             | 3145            | 3620      |       |    |
| Argus                                  |  | ARG OR SN/TM     | ARG OR GM/CT/FM | ARG OR HG |       |    |
|  |   | 3450             | 3550            | 4035      |       |    |
| Krysta                                 |  | KRY OR SN/TM     | KRY OR GM/CT/FM |           |       |    |
|  |   | 2865             | 2995            |           |       |    |











| Farretto<br>Collection<br>Door Handles |   | Finish Available |           |           |           |           |              |           |
|--|---|------------------|-----------|-----------|-----------|-----------|--------------|-----------|
|  |   | SN/CB            | GM/TC     | TM        | CT        | FM/TB     | HG/FE        | NM/MR     |
| Optio                                  |    | OPT OR SN        | OPT OR GM | OPT OR TM | OPT OR CT | OPT OR FM | OPT OR HG    |           |
|  |   | 3020             | 3145      | 3020      | 3145      | 3145      | 3620         |           |
| Velvet                                 |  | VLV OR SN/CB     | VLV OR TC | VLV OR TM | VLV OR CT | VLV OR TB | VLV OR HG/FE | VLV OR NM |
|  |   | 4345             | 4565      | 4345      | 4565      | 4565      | 5310         | 5420      |
| Morphos                                |  | MOR OR CB        |           |           |           |           |              | MOR OR MR |
|  |   | 4125             |           |           |           |           |              | 4125      |





| Farretto<br>Collection<br>Door Handles |   | Finish Available |           |           |
|--|---|------------------|-----------|-----------|
|  |   | CT               | SN        | GM        |
| Drop                                   |  | DRP 10 CT        | DRP 10 SN | DRP 10 GM |
|  |   | 3850             | 3850      | 3850      |
| Velvet                                 |  | VLV 10 CT        | VLV 10 SN | VLV 10 GM |
|  |   | 4690             | 4485      | 4690      |







| Farretto<br>Collection<br>Pull Handles |   | Finish Available |          |          |
|--|---|------------------|----------|----------|
|  |   | SN               | TM/GM    | HG/FE    |
| Teesta (Pair)                          |  | TES12PSN         | TES12PTM | TES12PFE |
|  | W/O Rose Model  | 5725             | 5725     | 6505     |
| Teesta(Pair)                           |  | TES18PSN         | TES18PTM | TES18PFE |
|  | W/O Rose Model  | 7475             | 7475     | 8290     |











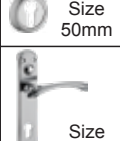

| Farretto<br>Collection<br>Pull Handles |  | Finish Available |           |           |
|--|--|------------------|-----------|-----------|
|  |  | SN               | TM/GM     | HG/FE     |
| Teesta (Pcs)                           |    | TES12PRSN        | TES12PRTM | TES12PRFE |
|  | On Rose Model  | 3130             | 3130      | 3620      |
| Teesta (Pcs)                           |    | TES18PRSN        | TES18PRTM | TES18PRFE |
|  | On Rose Model  | 3930             | 3930      | 4480      |
| Tero (Pair)                            |    | TRO12PSN         | TRO12PGM  | TRO12PHG  |
|  | W/O Rose Model   | 5140             | 5140      | 6075      |
| Mohana (Pair)                          |   | MOH12PSN         | MOH12PTM  | MOH12PFE  |
|  | W/O Rose Model   | 5550             | 5550      | 6465      |
| Forte (Pair)                           |  | FRT12PSN         | FRT12PGM  | FRT12PFE  |
|  | W/O Rose Model   | 4675             | 4675      | 5375      |
| Forza (Pair)                           |  | FRZ12PSN         | FRZ12PTM  | FRZ12PHG  |
|  | W/O Rose Model   | 5020             | 5020      | 5725      |
| Forza (Pair)                           |  | FRZ18PSN         | FRZ18PTM  | FRZ18PHG  |
|  | W/O Rose Model   | 6425             | 6425      | 7355      |
| Forza (Pcs)                            |  | FRZ12PRSN        | FRZ12PRTM | FRZ12PRHG |
|  | On Rose Model  | 2700             | 2700      | 3260      |
| Forza (Pcs)                            |  | FRZ18PRSN        | FRZ18PRTM | FRZ18PRHG |
|  | On Rose Model  | 3380             | 3380      | 3930      |

| Door Handles<br>Lever |   | Finish Available |             |             |
|-----------------------|---|------------------|-------------|-------------|
|                       |   | WD               | SS/SC       | PT/TM       |
| Riva                  |    |                  | RIV OR SS   | RIV OR PT   |
|                       |   |                  | 2980        | 2980        |
| Konica                |    |                  | KON OR SNSS | KON OR PT   |
|                       |   |                  | 3565        | 3565        |
| Speera                |    |                  | SPE OR SNWD | SPE OR PTTM |
|                       |   |                  | 3180        | 3180        |
| Polar                 |   |                  |             | POL OR PT   |
|                       |   |                  |             | 2895        |
| Ryder                 |  |                  | RYD OR SS   | RYD OR PT   |
|                       |   |                  | 3180        | 3180        |
| Trase                 |  | TRA OR SNWD      | TRA OR SNSS | TRA OR PTTM |
|                       |   | 3690             | 3690        | 3690        |
| Velvet                |  |                  | VLV OR SS   | VLV OR PT   |
|                       |   |                  | 3950        | 3950        |
| Velvet                |  |                  | VLV 10 SS   | VLV 10 PT   |
|                       |   |                  | 4070        | 4070        |
| Orbia                 |  | OBI OR SNWD      | OBI OR SC   |             |
|                       |   | 4520             | 4270        |             |
| Celisa                |  |                  | CLS OR SS   | CLS OR PT   |
|                       |   |                  | 3565        | 3565        |

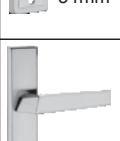
| Door Handles<br>Lever |  | Finish Available |             |             |
|-----------------------|--|------------------|-------------|-------------|
|                       |  | WD               | SS/SC       | PT/TM       |
| Drop                  |    |                  | DRP OR SS   | DRP OR PT   |
|                       |  |                  | 3180        | 3180        |
| Drop                  |    |                  | DRP 10 SS   | DRP 10 PT   |
|                       |  |                  | 3320        | 3320        |
| Terza                 |    |                  | TER OR SC   | TER OR PT   |
|                       |  |                  | 3815        | 3815        |
| Terza                 |    |                  | TER 10 SC   | TER 10 PT   |
|                       |  |                  | 4135        | 4135        |
| Flo                   |  |                  | FLL OR SS   | FLL OR PT   |
|                       |  |                  | 3690        | 3690        |
| Cornus                |  | COR OR SNWD      | COR OR SC   | COR OR PTTM |
|                       |  | 4645             | 4345        | 4345        |
| Stark                 |  |                  | STA OR SS   | STA OR PT   |
|                       |  |                  | 4425        | 4425        |
| Infinito              |  |                  | INF OR SNSS | INF OR PTTM |
|                       |  |                  | 3690        | 3690        |
| Pilot                 |  | PIL OR SSWD      | PIL OR SNSS |             |
|                       |  | 3825             | 3825        |             |
| Reflex                |  |                  | REF OR SS   | REF OR PT   |
|                       |  |                  | 3180        | 3180        |





| Door Handles<br>Lever |  | Finish Available |           |              |
|-----------------------|--|------------------|-----------|--------------|
|                       |  | WD               | SS/SC     | SN/PT        |
| Edge                  | <br>Size 28mm   |                  | EDG OR SS | EDG OR PT    |
|                       |  |                  | 4010      | 4010         |
| Flap                  | <br>Size 28mm   |                  |           | FLA OR SN/PT |
|                       |  |                  |           | 3690         |
| Liberte               | <br>Size 28mm   | LIB OR WD        | LIB OR SC |              |
|                       |  | 4395             | 4270      |              |
| Morphos               | <br>Size 54mm   |                  | MOR OR SS | MOR OR PT    |
|                       |  |                  | 3745      | 3745         |
| Morphos               | <br>Size 240mm |                  | MOR 10 SS | MOR 10 PT    |
|                       |  |                  | 4000      | 4000         |







| (Brass)<br>Door Handle Lever |  | Finish Available |             |
|------------------------------|--|------------------|-------------|
|                              |  | SS               | PT          |
| Vanya                        | <br>Size 50.4mm |                  | VNY OR PT   |
|                              |  |                  | 4700        |
| Anika                        | <br>Size 50.4mm |                  | ANK OR PT   |
|                              |  |                  | 4700        |
| Cadila                       | <br>Size 50.4mm | CAD OR SS        | CAD OR PT   |
|                              |  | 3825             | 3825        |
| Roccia                       | <br>Size 50.4mm |                  | ROC OR PTTM |
|                              |  |                  | 4655        |
| Nika                         | <br>Size 50.4mm | NK OR SS         | NK OR PT    |
|                              |  | 3845             | 3845        |
| Nika                         | <br>Size 252mm  | NK 10 SS         | NK 10 PT    |
|                              |  | 4125             | 4125        |
| Madonna                      | <br>Size 50.4mm | MA OR SS         | MA OR PT    |
|                              |  | 3935             | 3935        |



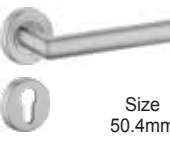

| (Brass)<br>Door Handle Lever |   | Finish Available |            |
|------------------------------|---|------------------|------------|
|                              |   | SS               | PT         |
| Dana                         | <br>Size 50.4mm   | DA OR SS         | DA OR PT   |
|                              |   | 3355             | 3355       |
| Dana                         | <br>Size 252mm    | DA 10 SS         | DA 10 PT   |
|                              |   | 3550             | 3550       |
| Juliet                       | <br>Size 50mm     | JL OR SS         | JL OR PT   |
|                              |   | 3935             | 3935       |
| Juliet                       | <br>Size 203mm    | JL 10 SS         | JL 10 PT   |
|                              |   | 4155             | 4155       |
| Zenith                       | <br>Size 50mm    | ZE OR SS         | ZE OR PT   |
|                              |   | 3935             | 3935       |
| Zenith                       | <br>Size 240mm  | ZE 10 SS         | ZE 10 PT   |
|                              |   | 4155             | 4155       |
| Sana                         | <br>Size 54mm   | SN OR SS         | SN OR PT   |
|                              |   | 4290             | 4290       |
| Sana                         | <br>Size 231mm  | SN 10 SS         | SN 10 PT   |
|                              |   | 4290             | 4290       |
| Xia                          | <br>Size 53mm   | XI OR SS         | XI OR PT   |
|                              |   | 4500             | 4500       |
| Xia                          | <br>Size 262mm  | XI 10 SS         | XI 10 PT   |
|                              |   | 4500             | 4500       |
| Blob                         | <br>Size 52.3mm | BB OR SS         | BB OR PT   |
|                              |   | 4535             | 4535       |
| Petal                        | <br>Size 52.3mm | PEA OR ZSC       | PEA OR ZPT |
|                              |   | 4035             | 4035       |

| Door Handles Solid<br>Stainless Steel (SS Grade-304) |   | 19mm dia  |
|--|---|-----------|
|  |   | SS        |
| Orius  |  | ORS OR SS |
|  |   | 3990      |
| Cella  |  | CLA OR SS |
|  |   | 3745      |
| Merina   |  | MER OR SS |
|  |   | 3300      |
| Axor   |  | AXO OR SS |
|  |   | 3300      |

| Door Handles<br>Stainless Steel (SS Grade-304) |  | Finish Available |
|--|--|------------------|
|  |  | SS               |
| Eden   |  Size 248mm  | ED 10 SS         |
|  |  | 2120             |
| Eden   |  Size 54mm  | ED OR SS         |
|  |  | 1790             |
| Primo  |  Size 248mm | PR 10 SS         |
|  |  | 2270             |
| Primo  |  Size 54mm  | PR OR SS         |
|  |  | 1945             |

| Door Handles<br>Stainless Steel (SS Grade-304) |  | 19mm dia  |           |           | 22mm dia |          |          |
|--|--|-----------|-----------|-----------|----------|----------|----------|
|  |  | SS        | GM        | TM        | SS       | GM       | TM       |
| D Type   |  Size 50mm     | SD OR SS  |           |           | SD OR SS | SD OR GM | SD OR TM |
|  |  | 1605      |           |           | 1670     |          |          |
|  |  Size 50mm     |           |           |           |          |          | 2455     |
| SLP  |  Size 50mm     |           |           |           |          | 2025     |          |
|  |  | SLP OR SS | SLP OR GM | SLP OR TM |          |          |          |
| SLP  |  Size 50.4mm  | 1605      |           |           |          |          |          |
|  |  |           |           | 2150      |          |          |          |
| SLP  |  Size 50.4mm |           | 1905      |           |          |          |          |
|  |  |           |           |           |          |          |          |

| Door Handles<br>Stainless Steel (SS Grade-304) |  | 19mm dia  | 22mm dia   |
|--|--|-----------|------------|
|  |  | SS        |            |
| Nika (SS)                                      | <br>Size 50.4mm     | NS OR SS  |            |
|  |  | 3390      |            |
| L Type   | <br>Size 50.4mm     | SL OR SS  | SL OR SS   |
|  |  | 1605      | 1670       |
| C Type   | <br>Size 51mm       |           | SC OR SS   |
|  |  |           | 2080       |
| SO   | <br>Size 50.4mm    | SO OR SS  |            |
|  |  | 1605      |            |
| SEP  | <br>Size 50.4mm   | SEP OR SS |            |
|  |  | 1605      |            |
| D Type   | <br>210 X 55 X 2  |           | SD OP SS 2 |
|  |  |           | 2720       |
| D Type   | <br>175 X 175 X 2 |           | SD OP SS 1 |
|  |  |           | 2720       |

| Rose (Stainless Steel) |  | Description  | SS           |
|------------------------|--|--|--------------|
| Handle Rose            |  | Rose (4pcs) Kit for Pull Handle (Available in 19 & 22 mm dia, Stainless Steel) | KT-1701 (19) |
|                        |  |  | 380          |
| Key Rose               |  | Key Rose Pair (Stainless Steel)  | KT-1702 (22) |
|                        |  |  | 395          |
| Handle Rose            |  | Rose (4pcs) Kit for Pull Handle (Available in 19 mm dia, Stainless Steel)      | KT-1703      |
|                        |  |  | 205          |
| Key Rose               |  | Key Rose Pair (Stainless Steel)  | KIT-1704     |
|                        |  |  | 395          |
| Key Rose               |  | Key Rose Pair (Stainless Steel)  | KIT-1705     |
|                        |  |  | 210          |











## SAFE TOUCH





*Door Handles with Anti-bacterial coating against Bacterial & Microbial Growth.*





**Antibacterial Coating Available Against Special Order.**



















| Pull Handles   | Finish Available |           |
|--|------------------|-----------|
|  | SS               | PT        |
| Teesta (Pair)<br><br>W/O Rose Model   | TES12PSS         | TES12PPT  |
|  | 5610             | 5610      |
| Teesta (Pcs)<br><br>On Rose Model     | TES12PRSS        | TES12PRPT |
|  | 3065             | 3065      |
| Teesta (Pair)<br><br>W/O Rose Model   | TES18PSS         | TES18PPT  |
|  | 7240             | 7240      |
| Teesta (Pcs)<br><br>On Rose Model    | TES18PRSS        | TES18PRPT |
|  | 3805             | 3805      |
| Tero (Pair)<br><br>W/O Rose Model   | TRO12PSS         | TRO12PPT  |
|  | 4965             | 4965      |
| Mohana (Pair)<br><br>W/O Rose Model | MOH12PSS         | MOH12PPT  |
|  | 5435             | 5435      |
| Forte (Pair)<br><br>W/O Rose Model  | FRT12PSS         | FRT12PPT  |
|  | 4440             | 4440      |
| Forza (Pair)<br><br>W/O Rose Model  | FRZ12PSS         | FRZ12PPT  |
|  | 4790             | 4790      |
| Forza (Pcs)<br><br>On Rose Model    | FRZ18PRSS        | FRZ18PRPT |
|  | 3260             | 3260      |
| Forza (Pair)<br><br>W/O Rose Model  | FRZ18PSS         | FRZ18PPT  |
|  | 6190             | 6190      |



| Pull Handles   | Finish Available |           |
|--|------------------|-----------|
|  | SS               | PT        |
| Forza (Pcs)<br><br>On Rose Model | FRZ12PRSS        | FRZ12PRPT |
|  | 2645             | 2645      |



| Pull Handles   | Finish Available |             |
|--|------------------|-------------|
|  | SS/SC            | PT          |
| Atina (Pair)<br><br>Size 255mm | AI 08 PR SS      | AI 08 PR PT |
|  | 4725             | 4725        |
| Atina (Pcs)<br><br>Size 305mm  | AI 10 PR SS      | AI 10 PR PT |
|  | 2600             | 2600        |



| Brass Pull Handles  | Finish Available |             |
|---|------------------|-------------|
|   | SS/SC            | PT          |
| Zara (Pair)<br><br>Size 250.4mm | ZA 08 PR SS      | ZA 08 PR PT |
|   | 3540             | 3540        |
| Zara (Pcs)<br><br>Size 300.4mm  | ZA 10 PR SS      | ZA 10 PR PT |
|   | 1955             | 1955        |
| Ebony (Pair)<br><br>Size 256mm  | EB 08 PR SS      | EB 08 PR PT |
|   | 4765             | 4765        |
| Ebony (Pcs)<br><br>Size 306mm   | EB 10 PR SS      | EB 10 PR PT |
|   | 2830             | 2830        |
| Leeba (Pcs)<br><br>Size 302mm   | LE 08 PR SS      | LE 08 PR PT |
|   | 2635             | 2635        |

| Brass Pull Handles |  | Finish Available |                |
|--------------------|--|------------------|----------------|
|                    |  | SS/SC            | PT             |
| Leeba (Pcs)        |  Size 357mm     | LE 10 PR SS      | LE 10 PR PT    |
|                    |  | 3575             | 3575           |
| Delfino (Pcs)      |  Size 252mm     | DE 08 PR SS WC   | DE 08 PR PT WC |
|                    |  | 2735             | 2735           |
| Delfino (Pcs)      |  Size 307mm     | DE 10 PR SS WC   | DE 10 PR PT WC |
|                    |  | 3010             | 3010           |
| Xia (Pair)         |  Size 252mm    | XI 08 PR SS      | XI 08 PR PT    |
|                    |  | 6010             | 6010           |
| Xia (Pcs)          |  Size 301mm   | XI 10 PR SS      | XI 10 PR PT    |
|                    |  | 3205             | 3205           |
| Sirocco (Pcs)      |  Size 293mm   | SR 12 PR SS      | SR 12 PR PT    |
|                    |  | 5295             | 5295           |
| Versa (Pair)       |  Size 171mm   | VE 06 PR SS      | VE 06 PR PT    |
|                    |  | 3350             | 3350           |
| Versa (Pcs)        |  Size 272.5mm | VE 10 PR SS      | VE 10 PR PT    |
|                    |  | 2965             | 2965           |
| Sana (Pair)        |  Size 256mm   | SN 08 PR SS      | SN 08 PR PT    |
|                    |  | 5560             | 5560           |





| Brass Pull Handles        |   | Finish Available            |               |
|---------------------------|---|-----------------------------|---------------|
|                           |   | SS/SC                       | PT            |
| Nika (Pair)               |  Size 262mm     | NK 10 PR SS                 | NK 10 PR PT   |
|                           |   | 7150                        | 7150          |
| Galaxy (Pair)             |  Size 252mm     | GA 06 PR SS,<br>GA 06 PR SC | GA 06 PR PT   |
|                           |   | 5535                        | 5535          |
| Arch (Pcs.)               |  Size 303mm     | ARH 10 P SS                 | ARH 10 P PT   |
|                           |   | 4125                        | 4125          |
| Madonna (Pair)            |  Size 210mm    | MA 10 PR SS                 | MA 10 PR PT   |
|                           |   | 4050                        | 4050          |
| Curve (Pair) - Glass Door |  Size 329.5mm | CUR 10 PGD SC               | CUR 10 PGD PT |
|                           |   | 5175                        | 5175          |
| Curve (Pair)              |  Size 279.5mm | CUR 08 PWD SC               | CUR 08 PWD PT |
|                           |   | 4360                        | 4360          |
| Curve (Pcs)               |  Size 329.5mm | CUR 10 PWD SC               | CUR 10 PWD PT |
|                           |   | 2625                        | 2625          |
| Curve (Pair) - Glass Door |  Size 279.5mm | CUR 08 PGD SC               | CUR 08 PGD PT |
|                           |   | 4840                        | 4840          |

| Stainless Steel Pull Handles (SS Grade-304)<br> |   | Finish Available |            |            |            |
|--|---|------------------|------------|------------|------------|
|  |   | SS               |            |            |            |
| Primo (Pair)<br>                                | Size<br>180mm<br>230mm<br>282mm<br>330mm<br><br>Fire Rated Upto 2 Hours | PR 06 P SS       | PR 08 P SS | PR 10 P SS | PR 12 P SS |
|  |   | 2040             | 2165       | 2355       | 2545       |
| Eden (Pair)<br>                                 | Size<br>184mm<br>234mm<br>286mm<br>334mm<br><br>Fire Rated Upto 2 Hours | ED 06 P SS       | ED 08 P SS | ED 10 P SS | ED 12 P SS |
|  |   | 1470             | 1620       | 1740       | 1905       |

| Stainless Steel Pull Handles (SS Grade-304)<br> |         | 19mm dia |            | 22mm dia |          |         |  |
|--|---------|----------|------------|----------|----------|---------|--|
|  |         | SS       | SS         | GM       | TM       |         |  |
| D Type (Pair)<br>                              | 150mm   | SD06PSS  | SD06PSS    |          |          |         |  |
|  |         | 1385     | 1470       |          |          |         |  |
|  | 200mm   | SD08PSS  | SD08PSS    | SD08PGM  | SD08PTM  |         |  |
|  |         | 1545     | 1620       | 2165     | 2505     |         |  |
|  | 250mm   | SD10PSS  | SD10PSS    | SD10PGM  | SD10PTM  |         |  |
|  |         | 1670     | 1755       | 2415     | 2805     |         |  |
|  | 300mm   | SD12PSS  | SD12PSS    | SD12PGM  | SD12PTM  |         |  |
|  |         | 1830     | 1905       | 2700     | 3130     |         |  |
|  |         |          | 25.4mm dia |          | 32mm dia |         |  |
|  |         |          | SS         | GM       | TM       | SS      |  |
|  | 400mm   | SD16PSS  | SD16PGM    | SD16PTM  |          | SD24PSS |  |
|  |         | 2910     | 3960       | 4595     | 600mm    | 4050    |  |
|  | 450mm   | SD18PSS  |            |          |          | SD30PSS |  |
|  |         | 3130     |            |          | 750mm    | 4860    |  |
| 500mm  | SD20PSS |          |            |          | SD36PSS  |         |  |
|  | 3360    |          |            | 900mm    | 5655     |         |  |
| 600mm  |         |          |            |          | SD48PSS  |         |  |
|  |         |          |            | 1200mm   | 7380     |         |  |



| Stainless Steel Pull Handles (SS Grade-304)<br> |       | 22mm dia   |            |            | 25.4mm dia |            |            | 32mm dia |
|---|-------|------------|------------|------------|------------|------------|------------|----------|
|   |       | SS         | GM         | TM         | SS         | GM         | TM         | SS       |
| H Type (Pair)<br>                              | 200mm | SH 08 P SS | SH 08 P GM | SH 08 P TM |            |            |            |          |
|   |       | 2165       | 2700       | 3130       |            |            |            |          |
|   | 250mm | SH 10 P SS | SH 10 P GM | SH 10 P TM |            |            |            |          |
|   |       | 2370       | 3035       | 3515       |            |            |            |          |
|   | 300mm | SH 12 P SS | SH 12 P GM | SH 12 P TM |            |            |            |          |
|   |       | 2545       | 3345       | 3880       |            |            |            |          |
|   | 350mm |            |            |            | SH 14 P SS | SH 14 P GM | SH 14 P TM |          |
|   |       |            |            |            | 3115       | 4170       | 4875       |          |
|   | 400mm |            |            |            | SH 16 P SS | SH 16 P GM | SH 16 P TM |          |
|   |       |            |            |            | 3360       | 4425       | 5135       |          |
|   | 450mm |            |            |            | SH 18 P SS |            |            |          |
|   |       |            |            |            | 3595       |            |            |          |
| 600mm   |       |            |            |            |            |            | SH 24 P SS |          |
|   |       |            |            |            |            |            | 4830       |          |
| 750mm   |       |            |            |            |            |            | SH 30 P SS |          |
|   |       |            |            |            |            |            | 5525       |          |
| 900mm   |       |            |            |            |            |            | SH 36 P SS |          |
|   |       |            |            |            |            |            | 6230       |          |
| 1200mm  |       |            |            |            |            |            | SH 48 P SS |          |
|   |       |            |            |            |            |            | 7635       |          |



| Stainless Steel Pull Handles (SS Grade-304)   |            | 22mm dia   |  |  |
|---|------------|------------|--|--|
|   |            | SS         |  |  |
| SOP Type (Pair)<br> | 200mm      | SO 08 P SS |  |  |
|   |            | 1620       |  |  |
|   | 250mm      | SO 10 P SS |  |  |
|   |            | 1740       |  |  |
| 300mm   | SO 12 P SS |            |  |  |
|   | 1905       |            |  |  |
| U Type (Pair)<br>   | 200mm      | SU 08 P SS |  |  |
|   |            | 2345       |  |  |
|   | 250mm      | SU 10 P SS |  |  |
|   |            | 2520       |  |  |
| 300mm   | SU 12 P SS |            |  |  |
|   | 2685       |            |  |  |





| Mortise Locks | Description   | Finish Available |      |       |       |       |      |          |      |      | Std. Pkg. |
|---------------|---|------------------|------|-------|-------|-------|------|----------|------|------|-----------|
|               |   | SS               | PT   | SN    | TM    | GM    | FM   | CT       | HG   | FE   |           |
| ML 124        |  | ML 124           |      |       |       |       |      |          |      |      | 20        |
|               |   | 1100             | 1100 | 1175  | 1175  | 1175  | 1175 | 1175     | 1775 | 1775 |           |
| ML 110        |  | ML 110           |      |       |       |       |      |          |      |      | 20        |
|               |   | SS/PT            |      | SN/TM |       | GM/FM |      | CT/CB/MR |      | NI   |           |
| ML 100        |  | ML 100           |      |       |       |       |      |          |      |      | 20        |
|               |   | HG/FE/VG         |      |       | SS/PT |       |      | NM       |      |      |           |
| ML 124 R      |  | ML 124 R         |      |       |       |       |      |          |      |      | 20        |
|               |   | SS               |      |       |       | PT    |      |          |      |      |           |
| MGT 602       |  | MGT 602          |      |       |       |       |      |          |      |      | 20        |
|               |   | SS               |      |       |       |       |      |          |      |      |           |
|               |   | 2500             |      |       |       |       |      |          |      |      |           |

| Mortise Locks | Description   | Finish Available |           |           | Std. Pkg. |
|---------------|---|------------------|-----------|-----------|-----------|
|               |   | NI               | SS        | PT        |           |
| ML 121        |  | ML 121 SS        | ML 121 PT | 20        |           |
|               |   | 1610             | 1610      |           |           |
| ML 120        |  | ML 120 NI        | ML 120 SS | ML 120 PT | 20        |
|               |   | 1480             | 1480      | 1480      |           |
| ML 111        |  | ML 111 NI        | ML 111 SS | 20        |           |
|               |   | 1025             | 1025      |           |           |
| ML 170        |  | ML 170 NI        |           | 20        |           |
|               |   | 775              |           |           |           |



| Mortise Locks | Description   | Finish Available | Std. Pkg. |
|---------------|---|------------------|-----------|
|               |   | SS               |           |
| ML110RC       |  | ML RC 110 SS     | 20        |
|               |   | 1025             |           |





| Mortise Locks | Description   | Finish Available |           | Std. Pkg. |
|---------------|---|------------------|-----------|-----------|
|               |   | NI               | SS        |           |
| ML 160 (ECO)  |  | ML 160 NI        |           | 20        |
|               |   | 840              |           |           |
| ML 166 SS     |  |                  | ML 166 SS | 20        |
|               |   |                  | 575       |           |







| Mortise Dead Locks | Description   | Finish Available |              |              |              |              | Std. Pkg. |    |
|--------------------|---|------------------|--------------|--------------|--------------|--------------|-----------|----|
|                    |   | NI               | SS/PT        | GM/TM        | FM/SN        | CB/MR        |           |    |
| ML 112             |  | ML 112 NI        | ML 112 SS/PT | ML 112 GM/TM | ML 112 FM/SN | ML 112 CB/MR | 20        |    |
|                    |   | 745              | 745          | 785          | 785          | 785          |           |    |
|                    |   |                  |              |              |              |              |           |    |
| ML 102             |  | SS/PT            |              | HG/VG        |              | FE           | NM        | 20 |
|                    |   | ML 102 SS/PT     |              | ML 102 HG/VG |              | ML 102 FE    | ML 102 NM |    |
|                    |   | 1080             |              | 1420         |              | 1350         | 1530      |    |
| ML 104             |  | SS               |              |              |              |              | 20        |    |
|                    |   | ML 104 SS        |              |              |              |              |           |    |
|                    |   | 1155             |              |              |              |              |           |    |











| Narrow Mortise Lock |   | Description  | Finish Available |           | Std. Pkg. |
|---------------------|---|--|------------------|-----------|-----------|
|                     |   |  | NI               | SS        |           |
| ML 140              |  | Mortise Lock With latch & Hook Bolt, Backset 21mm for Sliding Door | ML 140 NI        |           | 20        |
|                     |   |  | 950              |           |           |
| ML 141              |  | Mortise Lock with Hook Bolt Backset 21mm for Sliding Door          | ML 141 NI        |           | 20        |
|                     |   |  | 775              |           |           |
| ML 142              |  | Mortise Lock With Dead Bolt, Backset 21mm for Narrow Stile         |                  | ML 142 SS | 20        |
|                     |   |  |                  | 575       |           |
| ML 144              |  | Mortise Lock With Latch & Hook Bolt, Backset 21mm for Narrow Stile |                  | ML 144 SS | 20        |
|                     |   |  |                  | 575       |           |



| Mortise Lock & Latch for Steel Doors |   | Description                      | Finish Available |  | Std. Pkg. |
|--------------------------------------|---|----------------------------------|------------------|--|-----------|
|                                      |   |                                  | SS               |  |           |
| ML 100D                              |   | Mortise Dead Lock for Steel Door | ML 100 D SS      |  | 20        |
|                                      |   |                                  | 1005             |  |           |
| ML 100A                              |  | Mortise Lock for Steel Door      | ML100 A SS       |  | 20        |
|                                      |   |                                  | 1275             |  |           |
| ML 100L                              |  | Mortise Latch for Steel Door     | ML 100 L SS      |  | 20        |
|                                      |   |                                  | 900              |  |           |











| Mortise Latch |   | Description            | Finish Available |       |          |       | Std. Pkg. |
|---------------|---|------------------------|------------------|-------|----------|-------|-----------|
|               |   |                        | NI               | SS/PT | HG/FE/VG | NM    |           |
| ML 103        |  | Mortise Latch Standard | ML 103           |       |          |       | 20        |
|               |   |                        | 710              | 710   | 930      | 1040  |           |
| ML 103A       |  | Mortise Latch Standard | GM               | SN/TM | CT/FM    | CB/MR | 20        |
|               |   |                        | ML 103 A         |       |          |       |           |
|               |   |                        | 750              | 750   | 750      | 750   |           |

| Mortise Lock |  |  |                 |           |    |
|--------------|--|--|-----------------|-----------|----|
| Description  |  | Finish Available                           |                 | Std. Pkg. |    |
|              |  | SS   |                 |           |    |
| ML 100       | <br><small>Fire Rated Upto 2 Hours</small>   | Mortise Sash Lock-Fire Rated 50mm Backset  | ML 100 SS (FR)  | 1895      | 20 |
|              |  | Mortise Sash Lock-Fire Rated 55mm Backset  | ML 101 SS (FR)  |           |    |
| ML 100L      | <br><small>Fire Rated Upto 2 Hours</small>   | Mortise Latch Lock-Fire Rated 50mm Backset | ML 100L SS (FR) | 1700      | 20 |
|              |  | Mortise Latch Lock-Fire Rated 55mm Backset | ML 101L SS (FR) |           |    |
| ML 100D      | <br><small>Fire Rated Upto 2 Hours</small>   | Mortise Dead Lock-Fire Rated 50mm Backset  | ML 100D SS (FR) | 1700      | 20 |
|              |  | Mortise Dead Lock-Fire Rated 55mm Backset  | ML 101D SS (FR) |           |    |
| ML 103L      | <br><small>Fire Rated Upto 2 Hours</small> | Mortise Sash Lock-Fire Rated 55mm Backset  | ML 103L SS (FR) | 1480      | 20 |
| ML 103D      | <br><small>Fire Rated Upto 2 Hours</small> | Mortise Sash Lock-Fire Rated 55mm Backset  | ML 103D SS (FR) | 1480      | 20 |

| Euro Profile Cylinders | Description  | Finish Available |       |     |       |       |       | Std. Pkg. |
|------------------------|--|------------------|-------|-----|-------|-------|-------|-----------|
|                        |  | SS/PT            | SN/TM | GM  | FM/CT | CB/MR | HG/FE |           |
| CL 100                 |  Both Side Key 60mm | CL 100           |       |     |       |       |       | 20        |
|                        |  | 740              | 780   | 780 | 780   | 780   | 895   |           |
| CL 101                 |  Key and Knob 60mm  | CL 101           |       |     |       |       |       | 20        |
|                        |  | 820              | 865   | 865 | 865   | 865   | 975   |           |
| CL 102                 |  Coin & Knob 60mm   | CL 102           |       |     |       |       |       | 20        |
|                        |  | 740              | 780   | 780 | 780   | 780   | 895   |           |
| CL 106                 |  Both Side Key 70mm | CL 106           |       |     |       |       |       | 20        |
|                        |  | 795              | 835   | 835 | 835   | 835   | 960   |           |
| CL 107                 |  Key and Knob 70mm  | CL 107           |       |     |       |       |       | 20        |
|                        |  | 875              | 920   | 920 | 920   | 920   | 1045  |           |
| CL 108                 |  Coin & Knob 70mm   | CL 108           |       |     |       |       |       | 20        |
|                        |  | 795              | 835   | 835 | 835   | 835   | 960   |           |

| Euro Profile Cylinders | Description  | Finish Available |       |      |       |          |      | Std. Pkg. |
|------------------------|--|------------------|-------|------|-------|----------|------|-----------|
|                        |  | SS/PT            | SN/TM | GM   | FM/CT | HG/FE/VG | NM   |           |
| CL 200                 |  Both Side Key 60mm | CL 200           |       |      |       |          |      | 20        |
|                        |  | 1070             | 1150  | 1150 | 1150  | 1290     | 1395 |           |
| CL 201                 |  Key and Knob 60mm  | CL 201           |       |      |       |          |      | 20        |
|                        |  | 1145             | 1225  | 1225 | 1225  | 1360     | 1470 |           |
| CL 202                 |  Coin and Knob 60mm | CL 202           |       |      |       |          |      | 20        |
|                        |  | 1070             | 1150  | 1150 | 1150  | 1290     | 1395 |           |
| CL 206                 |  Both Side Key 70mm | CL 206           |       |      |       |          |      | 20        |
|                        |  | 1130             | 1215  | 1215 | 1215  | 1350     | 1455 |           |
| CL 207                 |  Key and Knob 70mm  | CL 207           |       |      |       |          |      | 20        |
|                        |  | 1205             | 1290  | 1290 | 1290  | 1435     | 1545 |           |
| CL 208                 |  Coin and Knob 70mm | CL 208           |       |      |       |          |      | 20        |
|                        |  | 1130             | 1215  | 1215 | 1215  | 1350     | 1455 |           |
| CL 203                 |  Both Side Key 80mm | CL 203           |       |      |       |          |      | 20        |
|                        |  | 1225             | 1320  | 1320 | 1320  | 1445     | 1555 |           |
| CL 204                 |  Key and Knob 80mm  | CL 204           |       |      |       |          |      | 20        |
|                        |  | 1295             | 1400  | 1400 | 1400  | 1540     | 1645 |           |
| CL 205                 |  Coin and Knob 80mm | CL 205           |       |      |       |          |      | 20        |
|                        |  | 1225             | 1320  | 1320 | 1320  | 1445     | 1555 |           |
| CL 214                 |  Both Side Key 90mm | CL 214           |       |      |       |          |      | 20        |
|                        |  | 1470             | 1585  | 1585 | 1585  | 1720     | 1825 |           |

| Euro Profile Cylinders | Description   | Finish Available |       |      |       |          |      | Std. Pkg. |
|------------------------|---|------------------|-------|------|-------|----------|------|-----------|
|                        |   | SS/PT            | SN/TM | GM   | FM/CT | HG/FE/VG | NM   |           |
| CL 215                 |  Key and Knob 90mm   | CL 215           |       |      |       |          |      | 20        |
|                        |   | 1550             | 1660  | 1660 | 1660  | 1805     | 1910 |           |
| CL 216                 |  Coin and Knob 90mm  | CL 216           |       |      |       |          |      | 20        |
|                        |   | 1470             | 1585  | 1585 | 1585  | 1720     | 1825 |           |
| CL 211                 |  Both Side Key 100mm | CL 211           |       |      |       |          |      | 20        |
|                        |   | 1550             | 1660  | 1660 | 1660  | 1805     | 1910 |           |
| CL 212                 |  Key and Knob 100mm  | CL 212           |       |      |       |          |      | 20        |
|                        |   | 1620             | 1735  | 1735 | 1735  | 1875     | 1985 |           |
| CL 213                 |  Coin and Knob 100mm | CL 213           |       |      |       |          |      | 20        |
|                        |   | 1550             | 1660  | 1660 | 1660  | 1805     | 1910 |           |

| Computerized Key Cylinders | Description   | Finish Available |      | Std. Pkg. |
|----------------------------|---|------------------|------|-----------|
|                            |   | SS               | PT   |           |
| CL 400                     |  Both Side Key 60mm  | CL 400           |      | 20        |
|                            |   | 795              | 795  |           |
| CL 401                     |  Key and Knob 60mm   | CL 401           |      | 20        |
|                            |   | 865              | 865  |           |
| CL 406                     |  Both Side Key 70mm  | CL 406           |      | 20        |
|                            |   | 850              | 850  |           |
| CL 407                     |  Key and Knob 70mm   | CL 407           |      | 20        |
|                            |   | 935              | 935  |           |
| CL 403                     |  Both Side Key 80mm  | CL 403           |      | 20        |
|                            |   | 1350             | 1350 |           |
| CL 404                     |  Key and Knob 80mm   | CL 404           |      | 20        |
|                            |   | 1410             | 1410 |           |
| CL 414                     |  Both Side Key 90mm  | CL 414           |      | 20        |
|                            |   | 1520             | 1520 |           |
| CL 415                     |  Key and Knob 90mm   | CL 415           |      | 20        |
|                            |   | 1595             | 1595 |           |
| CL 411                     |  Both Side Key 100mm | CL 411           |      | 20        |
|                            |   | 1595             | 1595 |           |
| CL 412                     |  Key and Knob 100mm  | CL 412           |      | 20        |
|                            |   | 1660             | 1660 |           |

CL-400 series cylinder will have 3 keys.

| Computerized Key Cylinders | Description         | Finish Available |       |          |       |          |      | Std. Pkg. |
|----------------------------|---------------------|------------------|-------|----------|-------|----------|------|-----------|
|                            |                     | SS/PT            | SN/TM | GM/CB/MR | FM/CT | HG/FE/VG | NM   |           |
| CL 500                     | Both Side Key 60mm  | CL 500           |       |          |       |          |      | 20        |
|                            |                     | 890              | 975   | 975      | 975   | 1095     | 1200 |           |
| CL 501                     | Key and Knob 60mm   | CL 501           |       |          |       |          |      | 20        |
|                            |                     | 965              | 1060  | 1060     | 1060  | 1175     | 1280 |           |
| CL 502                     | Coin and Knob 60mm  | CL 502           |       |          |       |          |      | 20        |
|                            |                     | 890              | 975   | 975      | 975   | 1095     | 1200 |           |
| CL 506                     | Both Side Key 70 mm | CL 506           |       |          |       |          |      | 20        |
|                            |                     | 955              | 1045  | 1045     | 1045  | 1165     | 1270 |           |
| CL 507                     | Key and Knob 70mm   | CL 507           |       |          |       |          |      | 20        |
|                            |                     | 1025             | 1125  | 1125     | 1125  | 1235     | 1340 |           |
| CL 508                     | Coin and Knob 70mm  | CL 508           |       |          |       |          |      | 20        |
|                            |                     | 955              | 1045  | 1045     | 1045  | 1165     | 1270 |           |
| CL 503                     | Both Side Key 80mm  | CL 503           |       |          |       |          |      |           |
|                            |                     | 1445             | 1585  | 1585     | 1585  | 1700     | 1805 |           |
| CL 504                     | Key and Knob 80mm   | CL 504           |       |          |       |          |      |           |
|                            |                     | 1510             | 1645  | 1645     | 1645  | 1760     | 1865 |           |
| CL 505                     | Coin and Knob 80mm  | CL 505           |       |          |       |          |      |           |
|                            |                     | 1445             | 1585  | 1585     | 1585  | 1700     | 1805 |           |
| CL 514                     | Both Side Key 90mm  | CL 514           |       |          |       |          |      |           |
|                            |                     | 1700             | 1760  | 1760     | 1760  | 1885     | 1995 |           |
| CL 515                     | Key and Knob 90mm   | CL 515           |       |          |       |          |      |           |
|                            |                     | 1680             | 1845  | 1845     | 1845  | 1975     | 2080 |           |
| CL 516                     | Coin and Knob 90mm  | CL 516           |       |          |       |          |      |           |
|                            |                     | 1615             | 1760  | 1760     | 1760  | 1885     | 1995 |           |
| CL 511                     | Both Side Key 100mm | CL 511           |       |          |       |          |      |           |
|                            |                     | 1680             | 1845  | 1845     | 1845  | 1975     | 2080 |           |
| CL 512                     | Key and Knob 100mm  | CL 512           |       |          |       |          |      |           |
|                            |                     | 1760             | 1920  | 1920     | 1920  | 2055     | 2160 |           |
| CL 513                     | Coin and Knob 100mm | CL 513           |       |          |       |          |      |           |
|                            |                     | 1765             | 1845  | 1845     | 1845  | 1975     | 2080 |           |

CL-500 series cylinder will have 5 keys.

| Euro Profile Cylinders | Description        | Finish Available |       |       |       |      |      | Std. Pkg. |
|------------------------|--------------------|------------------|-------|-------|-------|------|------|-----------|
|                        |                    | SS/PT            | SN/TM | HG/FE | CB/MR | NM   | VG   |           |
| DF 200                 | Both Side Key 60mm | DF 200           |       |       |       |      |      | 20        |
|                        |                    | 1780             | 2045  | 2180  | 1945  | 2175 | 2075 |           |
| DF 201                 | Key and Knob 60mm  | DF 201           |       |       |       |      |      | 20        |
|                        |                    | 1840             | 2110  | 2245  | 2005  | 2235 | 2135 |           |
| DF 206                 | Both Side Key 70mm | DF 206           |       |       |       |      |      | 20        |
|                        |                    | 1840             | 2110  | 2245  | 2005  | 2235 | 2135 |           |
| DF 207                 | Key and Knob 70mm  | DF 207           |       |       |       |      |      | 20        |
|                        |                    | 1965             | 2235  | 2380  | 2125  | 2370 | 2265 |           |
| DF 203                 | Both Side Key 80mm | DF 203           |       |       |       |      |      |           |
|                        |                    | 1965             | 2235  | 2380  | 2125  | 2370 | 2265 |           |
| DF 204                 | Key and Knob 80mm  | DF 204           |       |       |       |      |      |           |
|                        |                    | 2025             | 2300  | 2450  | 2190  | 2430 | 2330 |           |

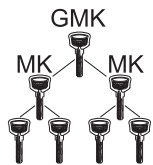
| DEFENDER 5<br>HIGH SECURITY EURO PROFILE CYLINDER                                    | Description                                | MK               | MK + GMK    |
|--|--|------------------|-------------|
|  | MK & GMK Charges per Euro Profile Cylinder |                  |             |
|  | Upto 20 Cylinders                          | 243 per cylinder | 243+243=486 |
|  | From 21 to 50 Cylinders                    | 325 per cylinder | 325+325=650 |
|  | From 51 and above Cylinders                | 451 per cylinder | 451+451=902 |

### Construction Key Cylinder

**Note: Construction Key cylinder is available in Euro Profile Cylinder Additional Charges for construction key cylinder (2 Keys) Rs.225/-**





**Owner Key**

Construction Key stop working when the Owner key is used for the very first time.



**Construction Key**

Separate construction Key to be used by the workers during construction.



**During Construction**

Only construction key being used



**After Possesion**











Owner Key used for the first time



**Thereafter**

Only Owner key is capable for Locking/Unlocking







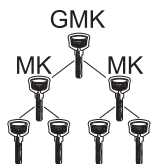



| Euro Profile Half Cylinders |   | Description         | Finish Available |      |
|-----------------------------|---|---------------------|------------------|------|
|                             |   |                     | SS               | PT   |
| CL 200H                     |    | One Side Key 60mm   | CL 200 H         |      |
|                             |   |                     | 940              | 940  |
| CL 201H                     |    | One Side Knob 60mm  | CL 201 H         |      |
|                             |   |                     | 940              | 940  |
| CL 206H                     |    | One Side Key 70mm   | CL 206 H         |      |
|                             |   |                     | 1020             | 1020 |
| CL 207H                     |    | One Side Knob 70mm  | CL 207 H         |      |
|                             |   |                     | 1020             | 1020 |
| CL 203H                     |    | One Side Key 80mm   | CL 203 H         |      |
|                             |   |                     | 1180             | 1180 |
| CL 204H                     |   | One Side Knob 80mm  | CL 204 H         |      |
|                             |   |                     | 1180             | 1180 |
| CL 214 H                    |  | One Side Key 90mm   | CL 214 H         |      |
|                             |   |                     | 1415             | 1415 |
| CL 215 H                    |  | One Side Knob 90mm  | CL 215 H         |      |
|                             |   |                     | 1440             | 1440 |
| CL 211H                     |  | One Side Key 100mm  | CL 211 H         |      |
|                             |   |                     | 1510             | 1510 |
| CL 212H                     |  | One Side Knob 100mm | CL 212 H         |      |
|                             |   |                     | 1510             | 1510 |

| Computerized Key Cylinders |  | Description         | Finish Available |      | Std. Pkg. |
|----------------------------|--|---------------------|------------------|------|-----------|
|                            |  |                     | SS               | PT   |           |
| CL 400H                    |    | One Side Key 60mm   | CL 400           |      | 20        |
|                            |  |                     | 665              | 665  |           |
| CL 401H                    |    | One Side Knob 60mm  | CL 401           |      | 20        |
|                            |  |                     | 735              | 735  |           |
| CL 406H                    |    | One Side Key 70mm   | CL 406           |      | 20        |
|                            |  |                     | 720              | 720  |           |
| CL 407H                    |    | One Side Knob 70mm  | CL 407           |      | 20        |
|                            |  |                     | 800              | 800  |           |
| CL 403H                    |    | One Side Key 80mm   | CL 403           |      | 20        |
|                            |  |                     | 1220             | 1220 |           |
| CL 404H                    |   | One Side Knob 80mm  | CL 404           |      | 20        |
|                            |  |                     | 1275             | 1275 |           |
| CL 414H                    |  | One Side Key 90mm   | CL 414           |      | 20        |
|                            |  |                     | 1385             | 1385 |           |
| CL 415H                    |  | One Side Knob 90mm  | CL 415           |      | 20        |
|                            |  |                     | 1465             | 1465 |           |
| CL 411H                    |  | One Side Key 100mm  | CL 411           |      | 20        |
|                            |  |                     | 1465             | 1465 |           |
| CL 412H                    |  | One Side Knob 100mm | CL 412           |      | 20        |
|                            |  |                     | 1530             | 1530 |           |



CL-400 series cylinder will have 3 keys.





| MK & GMK Charges per Euro Profile Cylinder  | Description                 | MK               | MK + GMK    |
|---|-----------------------------|------------------|-------------|
|  | Upto 20 Cylinders           | 177 per cylinder | 177+177=354 |
|   | From 21 to 50 Cylinders     | 271 per cylinder | 271+271=542 |
|   | From 51 and above Cylinders | 353 per cylinder | 353+353=706 |



| <b>PHANTOM</b><br>...Your Guardian |   | Product Name & Description                                      | IV   | NS   | MPT  |
|------------------------------------|---|---|------|------|------|
| PHA 300                            |    | <b>Trio Lock</b><br>Both Side Key Model                         | 2545 | 3955 | 4055 |
| PHA 301                            |    | <b>Trio Lock</b><br>Key and Knob Model                          | 2360 | 3580 | 3670 |
| PHA 302                            |    | <b>Trio Lock Dead Bolt</b><br>Both Side Key Model               | 2740 | 3685 | 3795 |
| PHA 303                            |    | <b>Trio Lock Dead Bolt</b><br>Key and Knob Model                | 2235 | 3335 | 3440 |
| PHA 103                            |    | <b>Dead Lock</b><br>Key and Knob Model                          | 1835 | 1980 | 2080 |
| PHA 102                            |    | <b>Dead Lock</b><br>Both Side Key Model                         | 2025 | 2180 | 2285 |
| PHA 100                            |  | <b>Night Latch</b><br>Both Side Key Model<br>For Inside Opening | 2620 | 2820 | 2915 |
| PHA 101                            |  | <b>Night Latch</b><br>Key and Knob Model<br>For Inside Opening  | 1715 | 2590 | 2700 |
| PHA104                             |  | <b>Night Latch</b><br>Both Side Key Model<br>For Inside Opening | 2005 | 2005 | 2205 |
| PHA105                             |  | <b>Night Latch</b><br>Key and Knob Model<br>For Inside Opening  | 1800 | 1800 | 2005 |

| <b>PHANTOM</b><br>...Your Guardian |   | Product Name & Description  | IV (O/S) | NS (O/S) | MPT (O/S) |
|------------------------------------|---|---|----------|----------|-----------|
| PHA 100                            |  | <b>Night Latch</b><br>Both Side Key Model<br>For Out side Opening | 2620     | 2820     | 2915      |
| PHA 101                            |  | <b>Night Latch</b><br>Key and Knob Model<br>For Out side Opening  | 1715     | 2590     | 2700      |
| PHA104                             |  | <b>Night Latch</b><br>Both Side Key Model<br>For Out side Opening | 2005     | 2005     | 2205      |
| PHA105                             |  | <b>Night Latch</b><br>Key and Knob Model<br>For Out side Opening  | 1800     | 1800     | 2005      |

| <b>PHANTOM</b><br>...Your Guardian |  | Product Name & Description               | IV   | NS   | MPT  |
|------------------------------------|--|--|------|------|------|
| PHA 200                            |  | <b>Verti Lock</b><br>Both Side Key Model | 2515 | 3400 | 3510 |
| PHA 201                            |  | <b>Verti Lock</b><br>Key and Knob Model  | 2040 | 2985 | 3090 |

| <b>SMART SERIES</b> |  | Product Name & Description  | IV (O/S) | NS (O/S) | MPT (O/S) |
|---------------------|--|---|----------|----------|-----------|
| SM 100              |    | <b>Night Latch</b><br>Both Side Key Model<br>For Out side Opening | 1610     | 1735     | 1840      |
| SM 101              |    | <b>Night Latch</b><br>Key and Knob Model<br>For Out side Opening  | 1570     | 1655     | 1755      |
| SM 104              |   | <b>Night Latch</b><br>Both Side Key Model<br>For Out side Opening | 1365     | 1500     | 1620      |
| SM 105              |  | <b>Night Latch</b><br>Key and Knob Model<br>For Out side Opening  | 1165     | 1295     | 1420      |

| <b>SMART SERIES</b> |  | Product Name & Description                                      | IV   | NS   | MPT  |
|---------------------|--|---|------|------|------|
| SM 100              |  | <b>Night Latch</b><br>Both Side Key Model<br>For Inside Opening | 1610 | 1735 | 1840 |
| SM 101              |  | <b>Night Latch</b><br>Key and Knob Model<br>For Inside Opening  | 1570 | 1655 | 1755 |
| SM 102              |  | <b>Dead Lock</b><br>Both Side Key Model                         | 1425 | 1535 | 1535 |
| SM 103              |  | <b>Dead Lock</b><br>Key and Knob Model                          | 1175 | 1260 | 1260 |
| SM 104              |  | <b>Night Latch</b><br>Both Side Key Model<br>For Inside Opening | 1365 | 1500 | 1620 |
| SM 105              |  | <b>Night Latch</b><br>Key and Knob Model<br>For Inside Opening  | 1165 | 1295 | 1420 |

Suitable For : Main Entrance Doors & 30-60 mm thick Doors  
Applicable for Inside/Outside door opening

Farrëtto  
Collection

| <b>PHANTOM</b><br>...Your Guardian |  | Product Name & Description                        | FM   | TM   | SN   | HGFE |
|------------------------------------|--|---|------|------|------|------|
| PHA 300                            |  | <b>Trio Lock</b><br>Both Side Key Model           | 4055 | 4055 | 4055 | 4450 |
| PHA 301                            |  | <b>Trio Lock</b><br>Key and Knob Model            | 3670 | 3670 | 3670 | 4130 |
| PHA 302                            |  | <b>Trio Lock Dead Bolt</b><br>Both Side Key Model | 3795 | 3795 | 3795 | 4045 |
| PHA 303                            |  | <b>Trio Lock Dead Bolt</b><br>Key and Knob Model  | 3440 | 3440 | 3440 | 3670 |

| <b>MK &amp; GMK charges per SM Series Rim Lock</b> |                             | Description      | MK          | MK + GMK |
|--|-----------------------------|------------------|-------------|----------|
|  | Upto 20 Cylinders           | 177 per cylinder | 177+177=354 |          |
|  | From 21 to 50 Cylinders     | 271 per cylinder | 271+271=542 |          |
|  | From 51 and above Cylinders | 353 per cylinder | 353+353=706 |          |

| <b>MK charges per Phantom Series Rim Lock</b> |                         | Description      | MK |
|---|-------------------------|------------------|----|
|   | Upto 20 Cylinders       | 243 per cylinder |    |
|   | From 21 to 40 Cylinders | 341 per cylinder |    |

- 01. Construction Key Charges: 225/-
- 02. Key Alike and common key feature is also available in both Phantom and Smart Series Rim Locks.

| <b>ZOD (Rim Pull Handle)</b> |  | Description                                  | SC         | MPT        |
|------------------------------|--|--|------------|------------|
| ZOD                          |  |  | ZOD00PR SC | ZOD00PT    |
|                              |  | Rim Pull Handle suitable with Phantom series | 1145       | 1145       |
| ZOD                          |  |  | ZOD0000 SC | ZOD0000 PT |
|                              |  | Rim Pull Handle Suitable With Phantom series | 1145       | 1145       |

**CONSTRUCTION KEY**

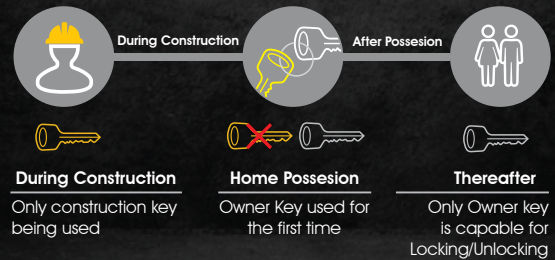





**HOME SOLUTION WITH MASTER KEY**



1 CENTRAL KEY WILL WORK FOR BOTH MAIN DOOR RIM LOCK & ALL THE INTERNAL DOORS



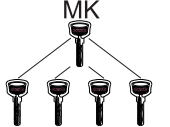

\*This feature only comes with smart series rim locks







| Knob Set             | Description  | Finish Available |      | Std. Pkg. |
|----------------------|--|------------------|------|-----------|
|                      |  | S/S              | A/B  |           |
| PRTO SM ETTO SM (SS) |  Entrance Smart | 955              |      | 30        |
| PRTO SM (SS)         |  Privacy Smart  | 890              |      | 30        |
| ETTO                 |  Entrance       | 1075             | 1150 | 24        |
| PRTO                 |  Privacy        | 1000             | 1070 | 24        |

| MK Charges per Knob Set   | Description       | MK                 |
|---|-------------------|--------------------|
|  | Upto 24 Cylinders | 149 extra per lock |



Note: Master Key Only Available in SS Finish.

| Multipurpose Locks | Description   | Finish Available | Std. Pkg. |
|--------------------|---|------------------|-----------|
|                    |   | NI/SS            |           |
| MP 390 (NI)        |  Multipurpose Lock             | 145              | 120       |
| MP 330 (NI)        |  Multipurpose Lock Eco (round) | 200              | 240       |
| MP 360 (KA)        |  Multipurpose Lock 22mm (sqr.) | 210              | 120       |
| MP 370 (KA)        |  Multipurpose Lock 32mm (sqr.) | 220              | 120       |

| Multipurpose Locks | Description  | Finish Available | Std. Pkg. |
|--------------------|--|------------------|-----------|
|                    |  | NI               |           |
| MP 460 (KA)        |  Multipurpose Lock 22mm (sqr.)            | 275              | 120       |
| MP 470             |  Multipurpose Lock 32mm (sqr.)            | 285              | 120       |
| MP 490             |  (SMART SUPERIA) Multipurpose Lock (sqr.) | 255              | 120       |
| AL 408             |  (SWITCH LOCK) Wardrobe Lock              | 425              | 60        |

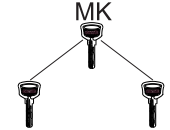
| Secura Lock  | Description  | Finish Available | Std. Pkg. |
|--------------|--|------------------|-----------|
|              |  | SS               |           |
| SECURA       |    | AL 400 (20)      | 20        |
|              |  | 605              |           |
|              |  | AL 400 (25)      | 20        |
| 605          |  |                  |           |
| SMART SECURA |    | AL 401 (32)      | 20        |
|              |  | 625              |           |
|              |  | SM 400 (23)      | 20        |
| 445          |  |                  |           |
| SECURA       |    | SM 401 (32)      | 20        |
|              |  | 480              |           |
|              |  | AL 402 (38)      | 20        |
| 695          |  |                  |           |
| SECURA       |    | AL 410 (20)      | 60        |
|              |  | 455              |           |
|              |  | AL 411 (25)      | 60        |
|              |  | 475              |           |
|              |  | AL 412 (32)      | 60        |
| 560          |  |                  |           |
| SECURA       |   | AL 210 (20)      | 60        |
|              |  | 410              |           |
|              |  | AL 211 (25)      | 60        |
|              |  | 445              |           |
|              |  | AL 212 (32)      | 60        |
| 505          |  |                  |           |
| SMART SECURA |  | SM 210 SS/IV     | 20        |
|              |  | 280 / 255        |           |
|              |  | SM 211 SS/IV     | 20        |
|              |  | 320 / 300        |           |
|              |  | SM 212 SS/IV     | 20        |
| 375 / 355    | 20   |                  |           |

| MK Charges per Secura Lock   | Description    | MK                   |
|--|----------------|----------------------|
|  | Upto 20 Locks  | 300                  |
|  | 21 to 40 Locks | 300 + 50 (PER LOCKS) |

| Sliding Lock | Description  | Finish Available | Std. Pkg. |
|--------------|--|------------------|-----------|
|              |  | NS               |           |
| AL 500       |  | AL 500 (25)      | 20        |
|              |  | 730              |           |
| AL 501       |  | AL 501 (32)      | 20        |
|              |  | 780              |           |

| Hextech Lock | Description  | Finish Available | Std. Pkg. |
|--------------|--|------------------|-----------|
|              |  | SS               |           |
| AL 450 SS    |  | AL 450           | 20        |
|              |  | 605              |           |

Note: Key Alike sets are available in code MP360, MP370, MP460, AL400, AL401, AL410, AL 411, AL 450, SM 400 & SM 401, AL 500, AL 501.

## GUIDELINES FOR ORDERING COMBO SET

### HL Lock Set (e.g ZOVI)

Available as a set of 8" mortise Handles & mortise lock body (ML 170) & with or without cylinder.

For ordering HL concept with variable cylinder options, use below mentioned product code system

| Handle Cylinder Option  | Cylinder Sizes     |              |
|-------------------------|--------------------|--------------|
|                         | 60mm               | 70mm         |
| Both Side Key           | HL ZOV SS          | HL ZOV 06 SS |
| Knob and Key            | HL ZOV A SS        | HL ZOV 07 SS |
| Coin and Knob           | HL ZOV 02 SS       | HL ZOV 08 SS |
| Mortise Latch           | HL ZOV B SS        |              |
| Mortise Lever Lock (KY) | HL ZOV SS (KY)     |              |
| Without Cylinder        | HL ZOV SS (W/O CL) |              |

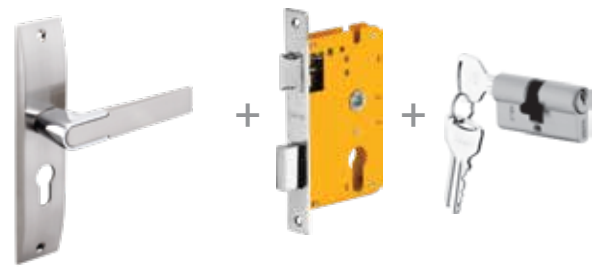

### ML Lock Set (e.g Zovi)

Available as a set of 10" Mortise handles & mortise lock body (ML110) & with or without cylinder.

For ordering ML concept with variable cylinder options, use below mentioned product code system.

| Handle Cylinder Option | Cylinder Sizes     |              |
|------------------------|--------------------|--------------|
|                        | 60mm               | 70mm         |
| Both Side Key          | ML ZOV SS          | ML ZOV 06 SS |
| Knob and Key           | ML ZOV A SS        | ML ZOV 07 SS |
| Coin and Knob          | ML ZOV 02 SS       | ML ZOV 08 SS |
| Without Cylinder       | ML ZOV SS (W/O CL) |              |





### ML OR Lock Set (e.g Zovi)

Available as a set of Rosette handles & mortise lock body (ML 110) & with or without cylinder.



For ordering ML OR concept with variable cylinder options, use below mentioned product code system.



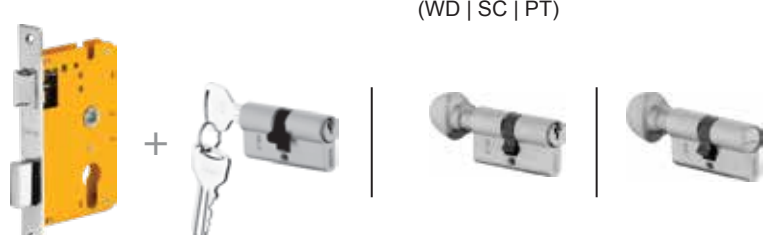

| Handle Cylinder Option | Cylinder Sizes        |                 |
|------------------------|-----------------------|-----------------|
|                        | 60mm                  | 70mm            |
| Both Side Key          | ML ZOV OR SS          | ML ZOV OR 06 SS |
| Knob and Key           | ML ZOV OR A SS        | ML ZOV OR 07 SS |
| Coin and Knob          | ML ZOV OR 02 SS       | ML ZOV OR 08 SS |
| Mortise Latch          | ML ZOV WR SS          |                 |
| Without Cylinder       | ML ZOV OR SS (W/O CL) |                 |

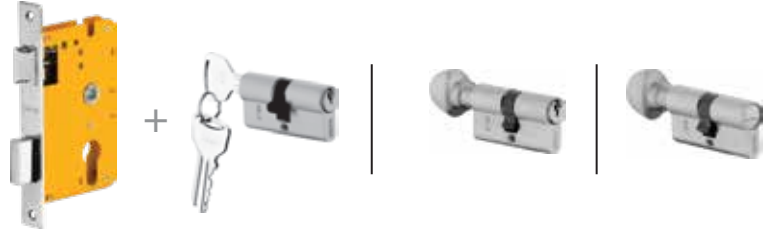

| Lock Sets   HL Series (8" On Plate) Combo Set   | Description                        | Finish Available |                     | Std. Pkg. |
|---|------------------------------------|------------------|---------------------|-----------|
|   |                                    | GMHG             | CBGM / MRGM<br>GMWD |           |
| <p><b>Kaira-X   Amoli</b></p>  <p>HL KAI (GMHG   GMWD) Size 200mm</p> <p>HL AML (CBGM   MRGM) Size 200mm</p>  | With Both Side Key Cylinder (60mm) | 3465             | 3360                | 4         |
|   | With Knob and Key Cylinder (60mm)  | 3515             | 3410                | 4         |
|   | With Coin and Knob Cylinder (60mm) | 3465             | 3360                | 4         |
|   | With Both Side Key Cylinder (70mm) | 3515             | 3410                | 4         |
|   | With Knob and Key Cylinder (70mm)  | 3580             | 3480                | 4         |
|   | With Coin and Knob Cylinder (70mm) | 3515             | 3410                | 4         |

| Lock Sets   HL Series (8" On Plate) Combo Set  | Description                        | Finish Available |      | Std. Pkg. |
|--|------------------------------------|------------------|------|-----------|
|  |                                    | SS/SC/ PT        | WD   |           |
| <p><b>Zovi   Kaira   Odiun   Texa</b></p>  <p>HL ZOV</p> <p>HL KAI</p> <p>HL ODI (WD   SC   PT)</p> <p>HL TEX</p>  | With Both Side Key Cylinder (60mm) | 2765             | 2835 | 4         |
|  | With Knob and Key Cylinder (60mm)  | 2835             | 2890 | 4         |
|  | With Coin and Knob Cylinder (60mm) | 2765             | 2835 | 4         |
|  | With Both Side Key Cylinder (70mm) | 2835             | 2890 | 4         |
|  | With Knob and Key Cylinder (70mm)  | 2890             | 2950 | 4         |
|  | With Coin and Knob Cylinder (70mm) | 2835             | 2890 | 4         |
|  | With Mortise Lever Lock (KY)       | 2210             | 2275 | 4         |

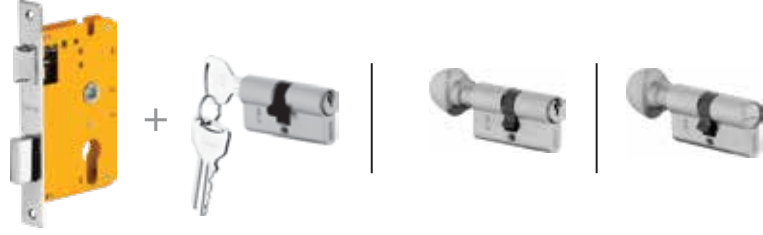
|  |                                    |      |  |   |
|--|------------------------------------|------|--|---|
| <p><b>Hale   Dash</b></p>  <p>HL HALE Size 190mm</p> <p>HL DAS Size 204.3mm</p>  | With Both Side Key Cylinder (60mm) | 3380 |  | 4 |
|  | With Knob and Key Cylinder (60mm)  | 3440 |  | 4 |
|  | With Coin and Knob Cylinder (60mm) | 3380 |  | 4 |
|  | With Both Side Key Cylinder (70mm) | 3440 |  | 4 |
|  | With Knob and Key Cylinder (70mm)  | 3500 |  | 4 |
|  | With Coin and Knob Cylinder (70mm) | 3440 |  | 4 |
|  | With Mortise Lever Lock (KY)       | 2465 |  | 4 |

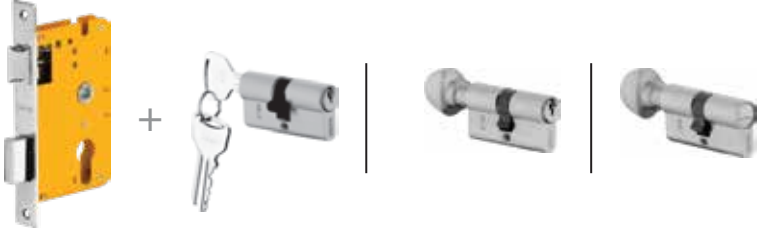
| Lock Sets   HL Series (8" On Plate) Combo Set   |                                    | Description | Finish Available | Std. Pkg. |
|---|------------------------------------|-------------|------------------|-----------|
|   |                                    |             | SS/SC/ PT        |           |
| <p><b>Deolo</b></p>  <p>HL DEO<br/>Size 200mm</p>   | With Both Side Key Cylinder (60mm) | 3705        | 4                |           |
|   | With Knob and Key Cylinder (60mm)  | 3765        | 4                |           |
|   | With Coin and Knob Cylinder (60mm) | 3705        | 4                |           |
|   | With Both Side Key Cylinder (70mm) | 3775        | 4                |           |
|   | With Knob and Key Cylinder (70mm)  | 3840        | 4                |           |
|   | With Coin and Knob Cylinder (70mm) | 3775        | 4                |           |
|   | With Mortise Lever Lock (KY)       | 2515        | 4                |           |
| <p><b>Zara</b></p>  <p>HL ZA<br/>Size 200mm</p>    | With Both Side Key Cylinder (60mm) | 3840        | 4                |           |
|   | With Knob and Key Cylinder (60mm)  | 3900        | 4                |           |
|   | With Coin and Knob Cylinder (60mm) | 3840        | 4                |           |
|   | With Both Side Key Cylinder (70mm) | 3910        | 4                |           |
|   | With Knob and Key Cylinder (70mm)  | 3980        | 4                |           |
|   | With Coin and Knob Cylinder (70mm) | 3910        | 4                |           |
|   | With Mortise Lever Lock (KY)       | 2550        | 4                |           |
| <p><b>Ceto   Elina</b></p>  <p>HL CO<br/>Size 185mm</p>  <p>HL ELN<br/>Size 200mm</p>  | With Both Side Key Cylinder (60mm) | 4010        | 4                |           |
|   | With Knob and Key Cylinder (60mm)  | 4075        | 4                |           |
|   | With Coin and Knob Cylinder (60mm) | 4010        | 4                |           |
|   | With Both Side Key Cylinder (70mm) | 4075        | 4                |           |
|   | With Knob and Key Cylinder (70mm)  | 4135        | 4                |           |
|   | With Coin and Knob Cylinder (70mm) | 4075        | 4                |           |
|   | With Mortise Lever Lock (KY)       | 2705        | 4                |           |

| Lock Sets   HL Series (8" On Plate) Combo Set   | Description                        | Finish Available |  | Std. Pkg. |
|---|------------------------------------|------------------|--|-----------|
|   |                                    | SS/SC/PT         |  |           |
| <b>Dave   Onix</b><br><br>HL DAV Size 190mm    HL ON Size 185mm<br>                                 | With Both Side Key Cylinder (60mm) | 4190             |  | 4         |
|   | With Knob and Key Cylinder (60mm)  | 4250             |  | 4         |
|   | With Coin and Knob Cylinder (60mm) | 4190             |  | 4         |
|   | With Both Side Key Cylinder (70mm) | 4250             |  | 4         |
|   | With Knob and Key Cylinder (70mm)  | 4320             |  | 4         |
|   | With Coin and Knob Cylinder (70mm) | 4250             |  | 4         |
|   | With Mortise Lever Lock (KY)       | 3000             |  | 4         |
| <b>Stella   Cosmo   Noha</b><br><br>HL ST Size 204mm    HL CS Size 204mm    HL NO Size 204mm<br> | With Both Side Key Cylinder (60mm) | 4250             |  | 4         |
|   | With Knob and Key Cylinder (60mm)  | 4320             |  | 4         |
|   | With Coin and Knob Cylinder (60mm) | 4250             |  | 4         |
|   | With Both Side Key Cylinder (70mm) | 4330             |  | 4         |
|   | With Knob and Key Cylinder (70mm)  | 4390             |  | 4         |
|   | With Coin and Knob Cylinder (70mm) | 4330             |  | 4         |
|   | With Mortise Lever Lock (KY)       | 2965             |  | 4         |

| Latch Sets   HL Series (8" On Plate) Combo Set | Description        | Finish Available |                  | Std. Pkg. |
|--|--------------------|------------------|------------------|-----------|
|  |                    | GMHG             | CBGM / MRGM GMWD |           |
| <b>Kaira-X</b>                                 | With Mortise Latch | 2740             | 2530             | 4         |
| <b>Amoli</b>                                   | With Mortise Latch |                  | 2530             | 4         |

| Latch Sets   HL Series (8" On Plate) Combo Set | Description        | Finish Available |      | Std. Pkg. |
|--|--------------------|------------------|------|-----------|
|  |                    | SS/SC/PT         | SSWD |           |
| <b>Zovi   Kaira   Odiun   Texa</b>             | With Mortise Latch | 2180             | 2245 | 4         |
| <b>Hale   Dash</b>                             | With Mortise Latch | 2410             |      | 4         |
| <b>Deolo</b>                                   | With Mortise Latch | 2605             |      | 4         |
| <b>Zara</b>                                    | With Mortise Latch | 2705             |      | 4         |
| <b>Ceto   Elina</b>                            | With Mortise Latch | 2705             |      | 4         |
| <b>Dave   Onix</b>                             | With Mortise Latch | 3000             |      | 4         |
| <b>Stella   Cosmo   Noha</b>                   | With Mortise Latch | 2965             |      | 4         |

| Lock Sets   K Series   | K series | Description                        | Finish Available- SC/PT |      |       | Std. Pkg. |
|--|----------|------------------------------------|-------------------------|------|-------|-----------|
|  |          |                                    | CHORD                   | OBLO | BRITO |           |
| <b>Chord   Oblo   Brito</b><br><br>HL CHO SC Size 178mm    HL OBL SC Size 175mm    HL BRT SC Size 178mm | K PLUS   | With Both Side Key Cylinder (60mm) | 2650                    | 2265 | 2615  | 4         |
|  |          | With Key & Knob Cylinder (60mm)    | 2715                    | 2330 | 2670  | 4         |
|  |          | With Both Side Key Cylinder (70mm) | 2715                    | 2330 | 2670  | 4         |
|  |          | With Key & Knob Cylinder (70mm)    | 2770                    | 2385 | 2735  | 4         |

| Lock Sets   K Series   | K series | Description                        | Finish Available- SC/PT |      | Std. Pkg. |
|--|----------|------------------------------------|-------------------------|------|-----------|
|  |          |                                    | SKEW                    | BOW  |           |
| <b>Skew   Bow</b><br><br>HL SKE SC Size 175mm    HL BOW SC Size 176mm | K PLUS   | With Both Side Key Cylinder (60mm) | 2615                    | 2650 | 4         |
|  |          | With Key & Knob Cylinder (60mm)    | 2670                    | 2715 | 4         |
|  |          | With Both Side Key Cylinder (70mm) | 2670                    | 2715 | 4         |
|  |          | With Key & Knob Cylinder (70mm)    | 2735                    | 2770 | 4         |



| Lock Sets   K Series   | Description                  | Finish Available- SC/PT |      |       | Std. |
|--|------------------------------|-------------------------|------|-------|------|
|  |                              | CHORD                   | OBLO | BRITO |      |
| <b>Chord   Oblo   Brito</b><br><br>HL CHO SC Size 178mm    HL OBL SC Size 175mm    HL BRT SC Size 178mm | With Mortise Lever Lock (KY) | 2040                    | 1545 | 1545  | 6    |
|  |                              |                         |      |       |      |

| Lock Sets   K Series   | Description                  | Finish Available- SC/PT |      | Std. Pkg. |
|--|------------------------------|-------------------------|------|-----------|
|  |                              | SKEW                    | BOW  |           |
| <b>Skew   Bow</b><br><br>HL SKE SC Size 175mm    HL BOW SC Size 176mm | With Mortise Lever Lock (KY) | 1700                    | 1740 | 6         |
|  |                              |                         |      |           |

| Lock Sets   Smart K Series   | Description                  | Finish Available- SS/PT |      | Std. Pkg. |
|--|------------------------------|-------------------------|------|-----------|
|  |                              | BRITO                   | OBLO |           |
| <b>Brito Smart   Oblo Smart</b><br><br>HL BRT KSS (SM) Size 175mm    HL OBL KSS (SM) Size 176mm | With Mortise Lever Lock (KY) | 1460                    | 1460 | 6         |
|  |                              |                         |      |           |

| Latch Sets   K Series | Description        | Finish Available | Std. Pkg. |
|-----------------------|--------------------|------------------|-----------|
|                       |                    | SC/PT            |           |
| Skew   Bow   Chord    | With Mortise Latch | 1555             | 4         |
| Oblo   Brito          | With Mortise Latch | 1405             | 4         |



| Lock Sets   ML Series (10" On Plate) Combo Set   | Description                        | Finish Available |                     | Std. Pkg. |
|--|------------------------------------|------------------|---------------------|-----------|
|  |                                    | GMHG             | CBGM / MRGM<br>GMWD |           |
| <b>Kaira-X   Amoli</b><br><br>ML KAI (GMHG   GMWD)    ML AML (CBGM   MRGM)<br> | With Both Side Key Cylinder (60mm) | 3900             | 3795                | 4         |
|  | With Knob and Key Cylinder (60mm)  | 3975             | 3870                | 4         |
|  | With Coin and Knob Cylinder (60mm) | 3900             | 3795                | 4         |
|  | With Both Side Key Cylinder (70mm) | 3975             | 3870                | 4         |
|  | With Knob and Key Cylinder (70mm)  | 4040             | 3935                | 4         |
|  | With Coin and Knob Cylinder (70mm) | 3975             | 3870                | 4         |





| Lock Sets   ML Series (10" On Plate) Combo Set  | Description                        | Finish Available |      | Std. Pkg. |
|---|------------------------------------|------------------|------|-----------|
|   |                                    | SS/SC/PT         | WD   |           |
| <b>Zovi   Kaira   Odiun   Texa</b><br><br>ML ZOV    ML KAI    ML ODI (WD   SC   PT)    ML TEX<br> | With Both Side Key Cylinder (60mm) | 3190             | 3265 | 4         |
|   | With Knob and Key Cylinder (60mm)  | 3265             | 3320 | 4         |
|   | With Coin and Knob Cylinder (60mm) | 3190             | 3265 | 4         |
|   | With Both Side Key Cylinder (70mm) | 3265             | 3320 | 4         |
|   | With Knob and Key Cylinder (70mm)  | 3320             | 3380 | 4         |
|   | With Coin and Knob Cylinder (70mm) | 3265             | 3320 | 4         |
| <b>Hale   Dash</b><br><br>ML HALE Size 240mm    ML DAS Size 253.8mm<br>                           | With Both Side Key Cylinder (60mm) | 3790             |      | 4         |
|   | With Knob and Key Cylinder (60mm)  | 3850             |      | 4         |
|   | With Coin and Knob Cylinder (60mm) | 3790             |      | 4         |
|   | With Both Side Key Cylinder (70mm) | 3850             |      | 4         |
|   | With Knob and Key Cylinder (70mm)  | 3910             |      | 4         |
|   | With Coin and Knob Cylinder (70mm) | 3850             |      | 4         |



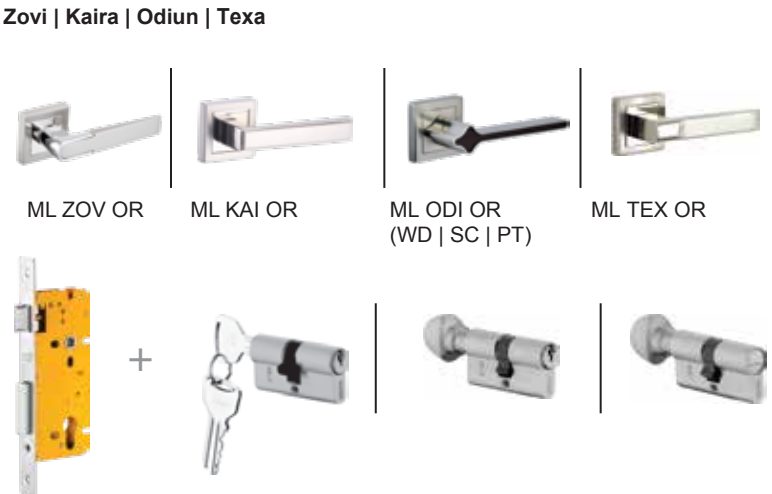
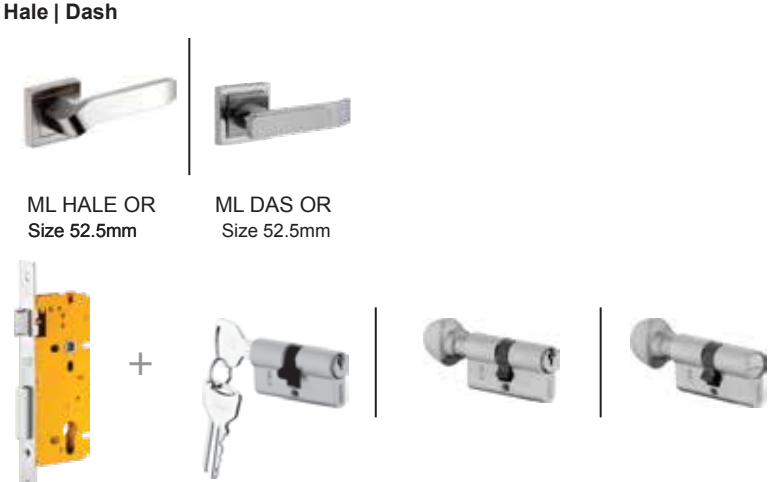

| Lock Sets   ML Series (10" On Plate) Combo Set  |   | Description                        | Finish Available | Std. Pkg. |
|---|---|------------------------------------|------------------|-----------|
|   |   |                                    | SS/SC/ PT        |           |
| <p><b>Deolo</b></p>  <p>ML DEO<br/>Size 250mm</p>   | With Both Side Key Cylinder (60mm)  | 4190                               | 4                |           |
|   | With Knob and Key Cylinder (60mm)   | 4250                               | 4                |           |
|   | With Coin and Knob Cylinder (60mm)  | 4190                               | 4                |           |
|   | With Both Side Key Cylinder (70mm)  | 4250                               | 4                |           |
|   | With Knob and Key Cylinder (70mm)   | 4320                               | 4                |           |
|   | With Coin and Knob Cylinder (70mm)  | 4250                               | 4                |           |
|   | <p><b>Zara</b></p>  <p>ML ZA<br/>Size 250mm</p>  | With Both Side Key Cylinder (60mm) | 4250             | 4         |
| With Knob and Key Cylinder (60mm)   |   | 4320                               | 4                |           |
| With Coin and Knob Cylinder (60mm)  |   | 4250                               | 4                |           |
| With Both Side Key Cylinder (70mm)  |   | 4330                               | 4                |           |
| With Knob and Key Cylinder (70mm)   |   | 4390                               | 4                |           |
| With Coin and Knob Cylinder (70mm)  |   | 4330                               | 4                |           |
| <p><b>Ceto   Elina</b></p>  <p>ML CO<br/>Size 250mm</p> <p>ML ELN<br/>Size 250mm</p>  |   | With Both Side Key Cylinder (60mm) | 4565             | 4         |
|   | With Knob and Key Cylinder (60mm)   | 4620                               | 4                |           |
|   | With Coin and Knob Cylinder (60mm)  | 4565                               | 4                |           |
|   | With Both Side Key Cylinder (70mm)  | 4620                               | 4                |           |
|   | With Knob and Key Cylinder (70mm)   | 4690                               | 4                |           |
|   | With Coin and Knob Cylinder (70mm)  | 4620                               | 4                |           |

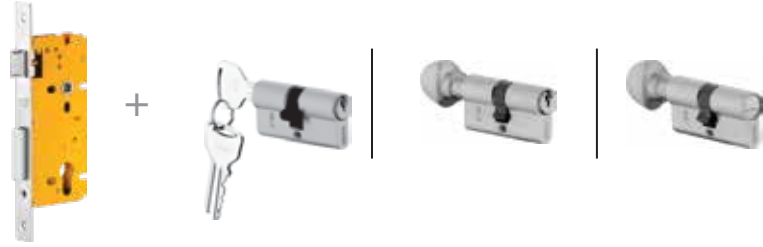
| Lock Sets   ML Series (10" On Plate) Combo Set  |  | Description                        | Finish Available | Std. Pkg. |
|---|--|------------------------------------|------------------|-----------|
|   |  |                                    | SS/SC/PT         |           |
| <b>Dave   Onix</b><br><br>ML DAV Size 240mm    ML ON Size 250mm<br>                                 |  | With Both Side Key Cylinder (60mm) | 4620             | 4         |
|   |  | With Knob and Key Cylinder (60mm)  | 4690             | 4         |
|   |  | With Coin and Knob Cylinder (60mm) | 4620             | 4         |
|   |  | With Both Side Key Cylinder (70mm) | 4705             | 4         |
|   |  | With Knob and Key Cylinder (70mm)  | 4765             | 4         |
|   |  | With Coin and Knob Cylinder (70mm) | 4705             | 4         |
| <b>Stella   Cosmo   Noha</b><br><br>ML ST Size 223mm    ML CS Size 245mm    ML NO Size 245mm<br> |  | With Both Side Key Cylinder (60mm) | 4740             | 4         |
|   |  | With Knob and Key Cylinder (60mm)  | 4795             | 4         |
|   |  | With Coin and Knob Cylinder (60mm) | 4740             | 4         |
|   |  | With Both Side Key Cylinder (70mm) | 4795             | 4         |
|   |  | With Knob and Key Cylinder (70mm)  | 4860             | 4         |
|   |  | With Coin and Knob Cylinder (70mm) | 4795             | 4         |

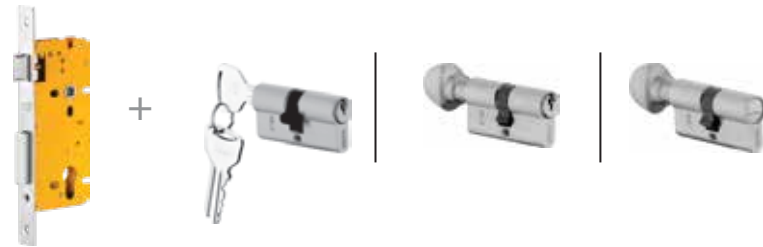
| Lock Sets   ML Series (On Rose) Combo Set   | Description                        | Finish Available |                     | Std. Pkg. |
|---|------------------------------------|------------------|---------------------|-----------|
|   |                                    | GMHG             | CBGM / MRGM<br>GMWD |           |
| <p><b>Kaira-X   Amoli</b></p>  <p>ML KAI OR<br/>(GMHG   GMWD)</p> <p>ML AML OR<br/>(CBGM   MRGM)</p> | With Both Side Key Cylinder (60mm) | 4025             | 3920                | 4         |
|   | With Knob and Key Cylinder (60mm)  | 4095             | 3995                | 4         |
|   | With Coin and Knob Cylinder (60mm) | 4025             | 3920                | 4         |
|   | With Both Side Key Cylinder (70mm) | 4095             | 3995                | 4         |
|   | With Knob and Key Cylinder (70mm)  | 4165             | 4060                | 4         |
|   | With Coin and Knob Cylinder (70mm) | 4095             | 3995                | 4         |



| Lock Sets   ML Series (On Rose) Combo Set   | Description                        | Finish Available |      | Std. Pkg. |
|---|------------------------------------|------------------|------|-----------|
|   |                                    | SS/SC/ PT        | WD   |           |
| <p><b>Zovi   Kaira   Odiun   Texa</b></p>  <p>ML ZOV OR</p> <p>ML KAI OR</p> <p>ML ODI OR<br/>(WD   SC   PT)</p> <p>ML TEX OR</p> | With Both Side Key Cylinder (60mm) | 3320             | 3380 | 4         |
|   | With Knob and Key Cylinder (60mm)  | 3380             | 3445 | 4         |
|   | With Coin and Knob Cylinder (60mm) | 3320             | 3380 | 4         |
|   | With Both Side Key Cylinder (70mm) | 3380             | 3445 | 4         |
|   | With Knob and Key Cylinder (70mm)  | 3445             | 3500 | 4         |
|   | With Coin and Knob Cylinder (70mm) | 3380             | 3445 | 4         |
| <p><b>Hale   Dash</b></p>  <p>ML HALE OR<br/>Size 52.5mm</p> <p>ML DAS OR<br/>Size 52.5mm</p>                                    | With Both Side Key Cylinder (60mm) | 3925             |      | 4         |
|   | With Knob and Key Cylinder (60mm)  | 3990             |      | 4         |
|   | With Coin and Knob Cylinder (60mm) | 3925             |      | 4         |
|   | With Both Side Key Cylinder (70mm) | 3990             |      | 4         |
|   | With Knob and Key Cylinder (70mm)  | 4050             |      | 4         |
|   | With Coin and Knob Cylinder (70mm) | 3990             |      | 4         |

| Lock Sets   ML Series (On Rose) Combo Set   |                                    | Description | Finish Available | Std. Pkg. |
|---|------------------------------------|-------------|------------------|-----------|
|   |                                    |             | SS/SC/PT         |           |
| <p><b>Deolo</b></p>  <p>ML DEO OR<br/>Size 50.4mm</p>   | With Both Side Key Cylinder (60mm) | 4330        | 4                |           |
|   | With Knob and Key Cylinder (60mm)  | 4390        | 4                |           |
|   | With Coin and Knob Cylinder (60mm) | 4330        | 4                |           |
|   | With Both Side Key Cylinder (70mm) | 4390        | 4                |           |
|   | With Knob and Key Cylinder (70mm)  | 4450        | 4                |           |
|   | With Coin and Knob Cylinder (70mm) | 4390        | 4                |           |
| <p><b>Zara</b></p>  <p>ML ZA OR<br/>Size 50.4mm</p>   | With Both Side Key Cylinder (60mm) | 4740        | 4                |           |
|   | With Knob and Key Cylinder (60mm)  | 4795        | 4                |           |
|   | With Coin and Knob Cylinder (60mm) | 4740        | 4                |           |
|   | With Both Side Key Cylinder (70mm) | 4795        | 4                |           |
|   | With Knob and Key Cylinder (70mm)  | 4860        | 4                |           |
|   | With Coin and Knob Cylinder (70mm) | 4795        | 4                |           |
| <p><b>Ceto   Elina</b></p>   <p>ML CO OR<br/>Size 54mm</p> <p>ML ELN OR<br/>Size 52.5mm</p>  | With Both Side Key Cylinder (60mm) | 4740        | 4                |           |
|   | With Knob and Key Cylinder (60mm)  | 4795        | 4                |           |
|   | With Coin and Knob Cylinder (60mm) | 4740        | 4                |           |
|   | With Both Side Key Cylinder (70mm) | 4795        | 4                |           |
|   | With Knob and Key Cylinder (70mm)  | 4860        | 4                |           |
|   | With Coin and Knob Cylinder (70mm) | 4795        | 4                |           |



| Lock Sets   ML Series (On Rose) Combo Set  | Description                        | Finish Available |  | Std. Pkg. |
|--|------------------------------------|------------------|--|-----------|
|  |                                    | SS/SC/PT         |  |           |
| <b>Dave   Onix</b><br><br>ML DAV OR<br>Size 54mm      ML ON OR<br>Size 52mm<br>  | With Both Side Key Cylinder (60mm) | 4795             |  | 4         |
|  | With Knob and Key Cylinder (60mm)  | 4860             |  | 4         |
|  | With Coin and Knob Cylinder (60mm) | 4795             |  | 4         |
|  | With Both Side Key Cylinder (70mm) | 4875             |  | 4         |
|  | With Knob and Key Cylinder (70mm)  | 4940             |  | 4         |
|  | With Coin and Knob Cylinder (70mm) | 4875             |  | 4         |
| <b>Stella   Cosmo   Noha</b><br><br>ML ST OR<br>Size 55mm      ML CS OR<br>Size 55mm      ML NO OR<br>Size 54mm<br> | With Both Side Key Cylinder (60mm) | 4875             |  | 4         |
|  | With Knob and Key Cylinder (60mm)  | 4940             |  | 4         |
|  | With Coin and Knob Cylinder (60mm) | 4875             |  | 4         |
|  | With Both Side Key Cylinder (70mm) | 4940             |  | 4         |
|  | With Knob and Key Cylinder (70mm)  | 5000             |  | 4         |
|  | With Coin and Knob Cylinder (70mm) | 4940             |  | 4         |





















| Latch Sets   ML Series (On Rose) Combo Set | Description        | Finish Available |                     | Std. Pkg. |
|--|--------------------|------------------|---------------------|-----------|
|  |                    | GMHG             | CBGM / MRGM<br>GMWD |           |
| <b>Kaira-X</b>                             | With Mortise Latch | 2475             | 2260                | 4         |
| <b>Amoli</b>                               | With Mortise Latch |                  | 2260                | 4         |

| Latch Sets   ML Series (On Rose) Combo Set | Description        | Finish Available |      | Std. Pkg. |
|--|--------------------|------------------|------|-----------|
|  |                    | SS/SC/PT         | WD   |           |
| <b>Zovi   Kaira   Odiun   Texa</b>         | With Mortise Latch | 1850             | 1900 | 4         |
| <b>Hale   Dash</b>                         | With Mortise Latch | 2065             |      | 4         |
| <b>Deolo</b>                               | With Mortise Latch | 2190             |      | 4         |
| <b>Zara</b>                                | With Mortise Latch | 2370             |      | 4         |
| <b>Ceto   Elina</b>                        | With Mortise Latch | 2370             |      | 4         |
| <b>Dave   Onix</b>                         | With Mortise Latch | 2445             |      | 4         |
| <b>Stella   Cosmo   Noha</b>               | With Mortise Latch | 2650             |      | 4         |

| Lock Sets With Lock Body & Without Cylinder   HL Combo Set |  |  | Finish Available |                     | Std. Pkg. |
|--|--|--|------------------|---------------------|-----------|
|  |  |  | GMHG             | CBGM / MRGM<br>GMWD |           |
| HL Series<br>(8" on Plate)                                 | <b>Kaira-X   Amoli</b><br> +    <br>HL KAI W/O CL (GMHG   GMWD)   HL AML W/O CL (CBGM   MRGM) |  | 2645             | 2540                | 4         |







| Lock Sets With Lock Body & Without Cylinder   HL Combo Set |  |   | Finish Available |      | Std. Pkg. |
|--|--|---|------------------|------|-----------|
|  |  |   | SS/SC/PT         | WD   |           |
| HL Series<br>(8" on Plate)                                 | <b>Zovi   Kaira   Odiun   Texa</b><br> +          <br>HL ZOV W/O CL   HL KAI W/O CL   HL ODI W/O CL   HL TEX W/O CL |   | 2295             | 2360 | 4         |
|  | HL Series<br>(8" on Plate)   | <b>Hale   Dash</b><br> +    <br>HL HALE W/O CL   HL DAS W/O CL  |                  | 2870 |           |
| HL Series<br>(8" on Plate)                                 |  | <b>Deolo</b><br> + <br>HL DEO W/O CL  |                  | 3225 |           |
|  | HL Series<br>(8" on Plate)   | <b>Zara</b><br> + <br>HL ZA W/O CL  |                  | 3370 |           |
| HL Series<br>(8" on Plate)                                 |  | <b>Ceto   Elina</b><br> +    <br>HL CO W/O CL   HL ELN W/O CL  |                  | 3540 |           |
|  | HL Series<br>(8" on Plate)   | <b>Dave   Onix</b><br> +    <br>HL DAV W/O CL   HL ON W/O CL   |                  | 3740 |           |
| HL Series<br>(8" on Plate)                                 |  | <b>Stella   Cosmo   Noha</b><br> +       <br>HL ST W/O CL   HL CS W/O CL   HL NO W/O CL |                  | 3800 |           |





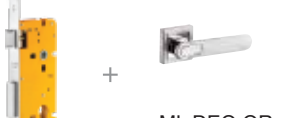

| Lock Sets With Lock Body & Without Cylinder   ML Combo Set |  |      | Finish Available   |                     | Std. Pkg. |
|--|--|------|--|---------------------|-----------|
|  |  |      | GMHG   | CBGM / MRGM<br>GMWD |           |
| ML Series<br>(10" on Plate)                                | <b>Kaira-X   Amoli</b><br> + <br>ML KAI W/O CL (GMHG   GMWD) |      | <br>ML AML W/O CL (CBGM   MRGM) |                     | 4         |
|  | 3080   | 2980 |  |                     |           |

| Lock Sets With Lock Body & Without Cylinder   ML Combo Set |  |  | Finish Available |    | Std. Pkg. |      |   |
|--|--|--|------------------|----|-----------|------|---|
|  |  |  | SS/ SC/ PT       | WD |           |      |   |
| ML Series<br>(10" on Plate)                                | <b>Zovi   Kaira   Odiun   Texa</b><br> +          <br>ML ZOV W/O CL   ML KAI W/O CL   ML ODI W/O CL   ML TEX W/O CL |  |                  |    | 2715      | 2775 | 4 |
|  |  |  |                  |    |           |      |   |
| ML Series<br>(10" on Plate)                                | <b>Hale   Dash</b><br> +    <br>ML HALE W/O CL   ML DAS W/O CL   |  |                  |    | 3300      | 4    |   |
|  |  |  |                  |    |           |      |   |
| ML Series<br>(10" on Plate)                                | <b>Deolo</b><br> + <br>ML DEO W/O CL   |  |                  |    | 3740      | 4    |   |
|  |  |  |                  |    |           |      |   |
| ML Series<br>(10" on Plate)                                | <b>Zara</b><br> + <br>ML ZA W/O CL   |  |                  |    | 3890      | 4    |   |
|  |  |  |                  |    |           |      |   |
| ML Series<br>(10" on Plate)                                | <b>Ceto   Elina</b><br> +    <br>ML CO W/O CL   ML ELN W/O CL   |  |                  |    | 4110      | 4    |   |
|  |  |  |                  |    |           |      |   |
| ML Series<br>(10" on Plate)                                | <b>Dave   Onix</b><br> +    <br>ML DAV W/O CL   ML ON W/O CL  |  |                  |    | 4205      | 4    |   |
|  |  |  |                  |    |           |      |   |
| ML Series<br>(10" on Plate)                                | <b>Stella   Cosmo   Noha</b><br> +       <br>ML ST W/O CL   ML CS W/O CL   ML NO W/O CL  |  |                  |    |           | 4320 | 4 |
|  |  |  |                  |    |           |      |   |



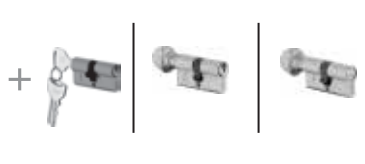



| Lock Sets With Lock Body & Without Cylinder   ML Combo Set (on Rose) |   |  | Finish Available |                     | Std. Pkg. |   |
|--|---|--|------------------|---------------------|-----------|---|
|  |   |  | GMHG             | CBGM / MRGM<br>GMWD |           |   |
| ML Series<br>(On Rose)   | <b>Kaira-X   Amoli</b><br><br>ML KAI OR W/O CL (GMHG   GMWD)      ML AML OR W/O CL (CBGM   MRGM) |  |                  | 3205                | 3105      | 4 |

|                        |   |  | Finish Available |      | Std. Pkg. |   |
|------------------------|---|--|------------------|------|-----------|---|
|                        |   |  | SS/ SC/ PT       | WD   |           |   |
| ML Series<br>(On Rose) | <b>Zovi   Kaira   Odiun   Texa</b><br><br>ML ZOV OR W/O CL      ML KAI OR W/O CL      ML ODI OR W/O CL |  |                  | 2870 | 2930      | 4 |
|                        | ML Series<br>(On Rose)  | <b>Hale   Dash</b><br><br>ML HALE OR W/O CL      ML DAS OR W/O CL                               |                  |      | 3465      |   |
| ML Series<br>(On Rose) |   | <b>Deolo</b><br><br>ML DEO OR W/O CL  |                  |      | 3880      |   |
|                        | ML Series<br>(On Rose)  | <b>Zara</b><br><br>ML ZA OR W/O CL  |                  |      | 4320      |   |
| ML Series<br>(On Rose) |   | <b>Ceto   Elina</b><br><br>ML CO OR W/O CL      ML ELN OR W/O CL                              |                  |      | 4320      |   |
|                        | ML Series<br>(On Rose)  | <b>Dave   Onix</b><br><br>ML DAV OR W/O CL      ML ON OR W/O CL                               |                  |      | 4375      |   |
| ML Series<br>(On Rose) |   | <b>Stella   Cosmo   Noha</b><br><br>ML ST OR W/O CL      ML CS OR W/O CL      ML NO OR W/O CL |                  |      | 4465      |   |

| Lock Sets   Brass   HL 8" Combo Set |   | Description  | Finish Available |      |      | Std. Pkg. |
|-------------------------------------|---|--|------------------|------|------|-----------|
|                                     |   |  | Brass            | SS   | PT   |           |
| HL Series (8" on Plate)             | Diva<br>   | With Both Side Key Cylinder (60mm)   | 4600             | 4600 | 4600 | 4         |
|                                     | HL 170<br>   | With Knob and Key Cylinder (60mm)  | 4665             | 4665 | 4665 | 4         |
|                                     |    | With Coin and Knob Cylinder (60mm)   | 4600             | 4600 | 4600 | 4         |
| HL Series (8" on Plate)             | Biva<br><br>+<br><br>HL 160 | With Mortise Lock<br> | 3350             | 3350 | 3350 | 4         |

| Latch Sets   Brass   HL 8" Combo Set |  | Description        | Finish Available |      |      | Std. Pkg. |
|--------------------------------------|--|--------------------|------------------|------|------|-----------|
|                                      |  |                    | Brass            | SS   | PT   |           |
| Diva                                 |  | With Mortise Latch | 3800             | 3800 | 3800 | 4         |
| Biva                                 |  | With Mortise Latch | 3235             | 3235 | 3235 | 4         |

| Lock Sets With Lock Body & Without Cylinder   Brass |  | Finish Available |      |      | Std. Pkg. |   |
|---|--|------------------|------|------|-----------|---|
|   |  | Brass            | SS   | PT   |           |   |
| HL Series (8" on Plate)                             | Diva<br><br>+<br><br>HL 170 W/O CL |                  | 4125 | 4125 | 4125      | 4 |

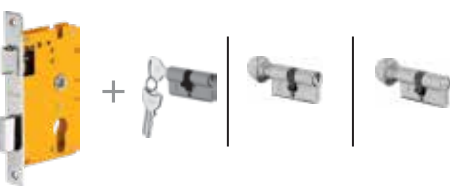
| Lock Sets   SS   HL 8" Combo Set |   | Description                        | Finish Available |      |  | Std. Pkg. |
|----------------------------------|---|------------------------------------|------------------|------|--|-----------|
|                                  |   |                                    | SS               |      |  |           |
| HL Series (8" on Plate)          | Eden I Primo<br> | With Both Side Key Cylinder (60mm) |                  | 3940 |  | 4         |
|                                  | HL ED   | With Knob and Key Cylinder (60mm)  |                  | 4000 |  | 4         |
|                                  | HL PR<br>        | With Coin and Knob Cylinder (60mm) |                  | 3940 |  | 4         |
|                                  |                  | With Both Side Key Cylinder (70mm) |                  | 4250 |  | 4         |
|                                  |   | With Knob and Key Cylinder (70mm)  |                  | 4320 |  | 4         |
|                                  |   | With Coin & Knob Cylinder (70mm)   |                  | 4250 |  | 4         |

| Latch Sets   SS   HL 8" Combo Set | Description        | Finish Available |  | Std. Pkg. |
|-----------------------------------|--------------------|------------------|--|-----------|
|                                   |                    | SS               |  |           |
| Eden I Primo                      | With Mortise Latch | 3135             |  | 4         |

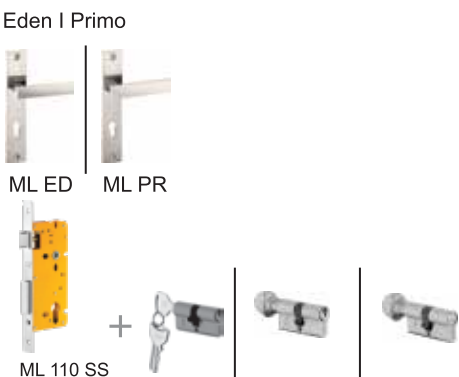

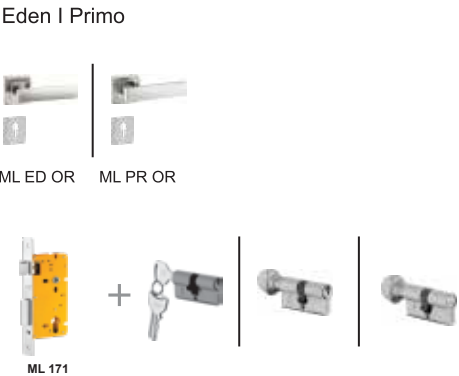
| Lock Sets   SS   ML 10" Combo Set   | Description                        | Finish Available |   | Std. Pkg. |
|---|------------------------------------|------------------|---|-----------|
|   |                                    | SS               |   |           |
| <b>ML Series (10" on Plate)</b><br> | Eden I Primo                       |                  |   |           |
|   | With Both Side Key Cylinder (60mm) | 4320             |   | 4         |
|   | With Knob and Key Cylinder (60mm)  | 4375             |   | 4         |
|   | With Coin and Knob Cylinder (60mm) | 4320             |   | 4         |
|   | With Both Side Key Cylinder (70mm) | 4620             |   | 4         |
|   | With Knob and Key Cylinder (70mm)  | 4690             |   | 4         |
| With Coin and Knob Cylinder (70mm)  | 4620                               |                  | 4 |           |

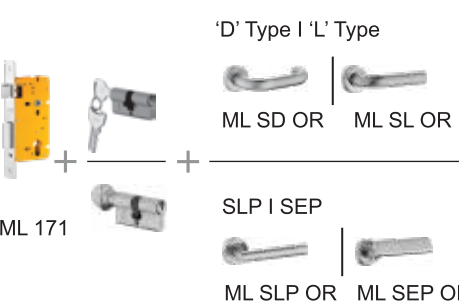

| Lock Sets   SS   ML On Rose Combo Set   | Description                        | Finish Available |   | Std. Pkg. |
|---|------------------------------------|------------------|---|-----------|
|   |                                    | SS               |   |           |
| <b>ML Series (On Rose)</b><br> | Eden I Primo                       |                  |   |           |
|   | With Both Side Key Cylinder (60mm) | 4320             |   | 4         |
|   | With Knob and Key Cylinder (60mm)  | 4375             |   | 4         |
|   | With Coin and Knob Cylinder (60mm) | 4320             |   | 4         |
|   | With Both Side Key Cylinder (70mm) | 4620             |   | 4         |
|   | With Knob and Key Cylinder (70mm)  | 4690             |   | 4         |
| With Coin and Knob Cylinder (70mm)  | 4620                               |                  | 4 |           |



| Latch Sets   SS   ML On Rose Combo Set | Description        | Finish Available |  | Std. Pkg. |
|--|--------------------|------------------|--|-----------|
|  |                    | SS               |  |           |
| Eden I Primo                           | With Mortise Latch | 3135             |  | 4         |



| Lock Sets   SS   ML On Rose Combo Set   | Description                        | SS       |          | Std. Pkg. |           |
|---|------------------------------------|----------|----------|-----------|-----------|
|   |                                    | 19mm dia | 22mm dia |           |           |
| <b>ML Series (On Rose)</b><br> | With Both Side Key Cylinder (60mm) | 3205     | 3245     | 4         |           |
|   | With Knob and Key Cylinder (60mm)  | 3265     | 3320     | 4         |           |
|   |                                    |          | SS       |           | Std. Pkg. |
|   | With Both Side Key Cylinder (60mm) | 3775     |          | 4         |           |
| With Knob and Key Cylinder (60mm)   | 3840                               |          | 4        |           |           |













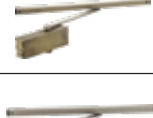
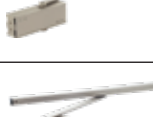

| Lock Sets With Lock Body & Without Cylinder I SS |   |  | Finish Available  | Std. Pkg. |   |
|--|---|--|---|-----------|---|
|  |   |  | SS  |           |   |
| HL Series<br>(8" on Plate)                       | <br>ML 170 | Eden I Primo<br>+<br><br>HL ED W/O CL | <br>HL PR W/O CL | 3500      | 4 |

| Lock Sets With Lock Body & Without Cylinder I SS |  |  | Finish Available  | Std. Pkg. |   |
|--|--|--|---|-----------|---|
|  |  |  | SS  |           |   |
| ML Series<br>(10" on Plate)                      | <br>ML 110 SS | Eden I Primo<br>+<br><br>ML ED W/O CL | <br>ML PR W/O CL | 3880      | 4 |







| Lock Sets With Lock Body & Without Cylinder I SS |   |   | Finish Available   | Std. Pkg. |   |
|--|---|---|--|-----------|---|
|  |   |   | SS   |           |   |
| ML Series<br>(On Rose)                           | <br>ML 171 | Eden I Primo<br>+<br><br>ML ED OR W/O CL | <br>ML PR OR W/O CL | 3880      | 4 |

| Lock Sets I SS I ML On Rose Combo Set (without cylinder) |   |  | SS   |          | Std. Pkg. |   |
|--|---|--|--|----------|-----------|---|
|  |   |  | 19mm dia   | 22mm dia |           |   |
| ML Series<br>(On Rose)                                   | <br>ML 171 | 'D' Type I 'L' Type<br>+<br><br>ML SD OR W/O CL | <br>ML SL OR W/O CL | 2775     | 2830      | 4 |

| Lock Sets I SS I ML On Rose Combo Set (without cylinder) |   |   | Finish Available  | Std. Pkg. |   |
|--|---|---|---|-----------|---|
|  |   |   | SS  |           |   |
| ML Series<br>(On Rose)                                   | <br>ML 171 | SLP I SEP<br>+<br><br>ML SLP OR W/O CL | <br>ML SEP OR W/O CL | 2775      | 4 |

| Door Closers           |  | Description                                  | Weight      | MRP  | Std. Pkg. |
|------------------------|--|--|-------------|------|-----------|
| FR 120                 | <br>Fire Rated Upto 2 Hours | Door Closer                                  | 120 Kg      | 6380 | 10        |
| FR 80                  | <br>Fire Rated Upto 2 Hours | Door Closer                                  | 80 Kg       | 3220 | 10        |
| FR 60                  | <br>Fire Rated Upto 2 Hours | Door Closer                                  | 60 Kg       | 2555 | 10        |
| DC 80 Ext. (WP) GM     |                             | Door Closer                                  | 80 Kg       | 4965 | 6         |
| DC 80 Ext (WP) ANTIQUE |                             | Door Closer Ext Antique                      | 80 Kg       | 4965 | 6         |
| DC 80 Ext. (WP) SS     |                            | Door Closer Ext With Palmet Arm in SS finish | 80 Kg       | 4965 | 6         |
| DC 80 Ext (WP) PAINT   |                           | Door Closer Ext With Palmet Arm              | 80 Kg       | 3680 | 6         |
| DC 80 Ext              |                           | Door Closer Ext                              | 80 Kg       | 3405 | 8         |
| DC 80 PDC              |                           | Door Closer PDC                              | 80 Kg       | 2845 | 8         |
| DC 80 PDC (WP)         |                           | Door Closer PDC With Palmet Arm              | 80 Kg       | 3095 | 8         |
| DC 85 CO               |                           | Concealed Door Closer                        | 60 to 85 Kg | 6245 | 4         |
| DC 65 CO               |                           | Concealed Door Closer                        | 40 to 65 Kg | 5905 | 4         |
| DC 40 CO               |                           | Concealed Door Closer                        | 40 Kg       | 5525 | 10        |
| DC 40 SM               |                           | Door Closer                                  | 40 Kg       | 1500 | 6         |
| DC 60 SM               |                           | Door Closer                                  | 60 Kg       | 1745 | 6         |
| DC 60 GM               |                           | Door Closer                                  | 60 Kg       | 1950 | 6         |

| Floor Spring |  | Description  | Weight      | MRP  | Std. Pkg. |
|--------------|--|--|-------------|------|-----------|
| FS 100       |    | Floor Spring (without BP/TP)                               | 65-100 Kg   | 6635 | 2         |
| FS 120       |    | Floor Spring (without BP/TP)                               | 100-120 Kg  | 6890 | 2         |
| FS 150       |    | Floor Spring (without BP/TP)                               | 120-150 Kg  | 7415 | 2         |
| FS 7070      |    | Floor Spring (without BP/TP)                               | Upto 70 Kg  | 4000 | 4         |
| FS 6080      |    | Floor Spring (without BP/TP)                               | Upto 90 Kg  | 4965 | 2         |
| FS 6120      |   | Floor Spring (without BP/TP)                               | Upto 120 Kg | 5465 | 2         |
| FS TP/BP     |  | Top - Bottom Pivot Suitable for Wooden Door/ Aluminum Door |             | 825  | 2         |

| Glass Combo Set |  | Description   | Weight      | SS    | GM    |
|-----------------|--|---|-------------|-------|-------|
| CS 70 WL        |  | Glass Combo Set With Lock Patch, Top & Bottom Patch Fittings          | Upto 70 Kg  | 7655  | 10085 |
| CS 70           |  | Glass Combo Set With Top & Bottom Patch Fittings (Without Lock Patch) | Upto 70 Kg  | 5500  | 8495  |
| CS 80 WL        |  | Glass Combo Set With Lock Patch, Top & Bottom Patch Fittings          | Upto 80 Kg  | 8475  | 12740 |
| CS 80           |  | Glass Combo Set With Top & Bottom Patch Fittings (Without Lock Patch) | Upto 80 Kg  | 6320  | 10615 |
| CS 100 WL       |  | Glass Combo Set With Lock Patch, Top & Bottom Patch Fittings          | Upto 100 Kg | 11520 | 14860 |
| CS 100          |  | Glass Combo Set With Top & Bottom Patch Fittings (Without Lock Patch) | Upto 100 Kg | 9345  | 13270 |

## Door Weight Calculation Chart for Door Closer & Floor Spring

### Glass Door Weight

| Size       |             |                | Weight (Kg) | Size       |             |                | Weight (Kg) |
|------------|-------------|----------------|-------------|------------|-------------|----------------|-------------|
| Width (ft) | Height (ft) | Thickness (mm) |             | Width (ft) | Height (ft) | Thickness (mm) |             |
| 2.5        | 7           | 6              | 24.3        | 2.5        | 7           | 10             | 40.5        |
| 2.5        | 8           | 6              | 27.8        | 2.5        | 8           | 10             | 46.3        |
| 3          | 7           | 6              | 29.1        | 3          | 7           | 10             | 48.6        |
| 3          | 8           | 6              | 33.3        | 3          | 8           | 10             | 55.5        |
| 3.5        | 7           | 6              | 34.0        | 3.5        | 7           | 10             | 56.7        |
| 4          | 8           | 6              | 44.4        | 4          | 8           | 10             | 74.0        |
| 4.5        | 7           | 6              | 43.7        | 4.5        | 7           | 10             | 72.9        |
| 4.5        | 8           | 6              | 50.0        | 4.5        | 8           | 10             | 83.3        |
| 5          | 7           | 6              | 48.6        | 5          | 7           | 10             | 81.0        |
| 5          | 8           | 6              | 55.5        | 5          | 8           | 10             | 92.5        |

|     |   |   |      |
|-----|---|---|------|
| 2.5 | 7 | 8 | 32.4 |
| 2.5 | 8 | 8 | 37.0 |
| 3   | 7 | 8 | 38.9 |
| 3   | 8 | 8 | 44.4 |
| 3.5 | 7 | 8 | 45.3 |
| 4   | 8 | 8 | 59.2 |
| 4.5 | 7 | 8 | 58.3 |
| 4.5 | 8 | 8 | 66.6 |
| 5   | 7 | 8 | 64.8 |
| 5   | 8 | 8 | 74.0 |

|     |   |    |       |
|-----|---|----|-------|
| 2.5 | 7 | 12 | 48.6  |
| 2.5 | 8 | 12 | 55.5  |
| 3   | 7 | 12 | 58.3  |
| 3   | 8 | 12 | 66.6  |
| 3.5 | 7 | 12 | 68.0  |
| 4   | 8 | 12 | 88.8  |
| 4.5 | 7 | 12 | 87.4  |
| 4.5 | 8 | 12 | 99.9  |
| 5   | 7 | 12 | 97.2  |
| 5   | 8 | 12 | 111.0 |

### Indian Teak Door Weight

| Size       |             |                | Material Density (FOS) | Weight (Kg) |
|------------|-------------|----------------|------------------------|-------------|
| Width (ft) | Height (ft) | Thickness (mm) |                        |             |
| 2.5        | 7           | 36.1           | 1.25                   | 27.1        |
| 2.5        | 8           | 41.3           | 1.25                   | 31.0        |
| 3          | 7           | 43.4           | 1.25                   | 32.5        |
| 3          | 8           | 49.6           | 1.25                   | 37.2        |
| 3.5        | 7           | 50.6           | 1.25                   | 37.9        |
| 4          | 8           | 66.1           | 1.25                   | 49.6        |
| 4.5        | 7           | 65.0           | 1.25                   | 48.8        |
| 4.5        | 8           | 74.3           | 1.25                   | 55.7        |
| 5          | 7           | 72.3           | 1.25                   | 54.2        |
| 5          | 8           | 82.6           | 1.25                   | 61.9        |

### Indian Teak Door Weight

| Size       |             |                | Material Density (FOS) | Weight (Kg) |
|------------|-------------|----------------|------------------------|-------------|
| Width (ft) | Height (ft) | Thickness (mm) |                        |             |
| 2.5        | 7           | 43.4           | 1.5                    | 32.5        |
| 2.5        | 8           | 49.6           | 1.5                    | 37.2        |
| 3          | 7           | 52.0           | 1.5                    | 39.0        |
| 3          | 8           | 59.5           | 1.5                    | 44.6        |
| 3.5        | 7           | 60.7           | 1.5                    | 45.5        |
| 4          | 8           | 79.3           | 1.5                    | 59.5        |
| 4.5        | 7           | 78.0           | 1.5                    | 58.5        |
| 4.5        | 8           | 89.2           | 1.5                    | 66.9        |
| 5          | 7           | 86.7           | 1.5                    | 65.0        |
| 5          | 8           | 99.1           | 1.5                    | 74.3        |

|     |   |       |      |      |
|-----|---|-------|------|------|
| 2.5 | 7 | 50.6  | 1.75 | 37.9 |
| 2.5 | 8 | 57.8  | 1.75 | 43.4 |
| 3   | 7 | 60.7  | 1.75 | 45.5 |
| 3   | 8 | 69.4  | 1.75 | 52.0 |
| 3.5 | 7 | 70.8  | 1.75 | 53.1 |
| 4   | 8 | 92.5  | 1.75 | 69.4 |
| 4.5 | 7 | 91.1  | 1.75 | 68.3 |
| 4.5 | 8 | 104.1 | 1.75 | 78.0 |
| 5   | 7 | 101.2 | 1.75 | 75.9 |
| 5   | 8 | 115.6 | 1.75 | 86.7 |

|     |   |       |   |      |
|-----|---|-------|---|------|
| 2.5 | 7 | 57.8  | 2 | 43.4 |
| 2.5 | 8 | 66.1  | 2 | 49.6 |
| 3   | 7 | 69.4  | 2 | 52.0 |
| 3   | 8 | 79.3  | 2 | 59.5 |
| 3.5 | 7 | 80.9  | 2 | 60.7 |
| 4   | 8 | 105.7 | 2 | 79.3 |
| 4.5 | 7 | 104.1 | 2 | 78.0 |
| 4.5 | 8 | 118.9 | 2 | 89.2 |
| 5   | 7 | 115.6 | 2 | 86.7 |
| 5   | 8 | 132.1 | 2 | 99.1 |

#### Note:

1. For Selection of Floor Spring for glass door factor of safety should be taken as 1.
2. For Selection of Door closers for wooden door factor of safety should be taken as 1.

| SS 2 Ball Bearing Hinge (with screw) |  | Size             | Code    | Finish<br>SS | Std. Pkg. |
|--------------------------------------|--|------------------|---------|--------------|-----------|
|                                      |  | 76 X 64 X 2MM    | HG 1150 | 215          | 40        |
|                                      |  | 102 X 76 X 2.5MM | HG 1151 | 290          | 40        |
|                                      |  | 127 X 76 X 2.5MM | HG 1152 | 310          | 40        |
|                                      |  | 102 X 76 X 3MM   | HG 1153 | 330          | 40        |
|                                      |  | 127 X 76 X 3MM   | HG 1154 | 370          | 40        |

| SS Grade 304 | SS 2 Ball Bearing Hinge (with screw) |  | Size             | Code      | Finish<br>SS           | Std. Pkg. |
|--------------|--------------------------------------|--|------------------|-----------|------------------------|-----------|
|              |                                      |  | 102 X 76 X 2.5MM | HG 1151 A | 355                    | 40        |
|              |                                      |  | 127 X 76 X 2.5MM | HG 1152 A | 390                    | 40        |
|              |                                      |  | 102 X 76 X 3MM   | HG 1153 A | 400                    | 40        |
|              |                                      |  | 127 X 76 X 3MM   | HG 1154 A | 480                    | 40        |
|              |                                      |  |                  |           | Upto 2 Hour Fire Rated |           |

| SS Pin Type Welded Hinge (without screw) |  | Size         | Code      | Finish<br>SS | Std. Pkg. |
|--|--|--------------|-----------|--------------|-----------|
|  |  | 75x48x1.7MM  | HG5150SS  | 65           | 60        |
|  |  | 75x48x2.5MM  | HG5150HSS | 105          | 60        |
|  |  | 100x58x1.9MM | HG5151SS  | 120          | 60        |
|  |  | 100x61x2.5MM | HG5151HSS | 155          | 60        |
|  |  | 125x64x1.9MM | HG5152SS  | 165          | 60        |
|  |  | 125x65x2.5MM | HG5152HSS | 205          | 60        |

| SS Grade 304 | SS 2 Ball Bearing Hinge (with screw) |  | Size             | Code        | Finish<br>SS | Std. Pkg. |
|--------------|--------------------------------------|--|------------------|-------------|--------------|-----------|
|              |                                      |  | 127 X 76 X 2.5MM | HGRC 1152 A | 590          | 40        |
|              |                                      |  | 102 X 76 X 3MM   | HGRC 1153 A | 550          | 40        |

| SS Pin Type Round Corner Hinge (Without Screw) |  | Size             | Code       | Finish<br>SS | Std. Pkg. |
|--|--|------------------|------------|--------------|-----------|
|  |  | 127 X 76 X 2.5MM | HGRC6051SS | 255          | 40        |

| For Steel Door | SS 2 Ball Bearing Hinge (with screw) |  | Size       | Code    | Finish<br>SS | Std. Pkg. |
|----------------|--------------------------------------|--|------------|---------|--------------|-----------|
|                |                                      |  | 102x76x3mm | HG 1253 | 515          | 40        |

Fire Rated Upto 2 Hours

| SS Flush Hinge (With Screw) |  | Size                   | Code         | Finish<br>SS |
|-----------------------------|--|------------------------|--------------|--------------|
|                             |  | 100x37x2.5 MM (SS 304) | BHG6150A SS  | 345          |
|                             |  | 100x37x2.5 MM          | BHG6150SS SM | 275          |











| Round Dia - 10mm | Brass Tower Bolt (with screw) |             | Finish        |       |      |
|------------------|-------------------------------|-------------|---------------|-------|------|
|                  |                               | Description | EP            | SS/PT |      |
|                  |                               |             | TR 310 - 03"  | 335   | 395  |
|                  |                               |             | TR 410 - 04"  | 540   | 595  |
|                  |                               |             | TR 610 - 06"  | 690   | 730  |
|                  |                               |             | TR 810 - 08"  | 835   | 875  |
|                  |                               |             | TR 1010 - 10" | 1015  | 1055 |
| TR 1210 - 12"    |                               |             | 1200          | 1255  |      |

| Square Shape, Dia - 10mm | SS Tower Bolt (with screw) |               | Finish<br>SS | Std. Pkg. |
|--------------------------|----------------------------|---------------|--------------|-----------|
|                          |                            | TS-410 - 04"  | 155          | 60        |
|                          |                            | TS-610 - 06"  | 225          | 60        |
|                          |                            | TS-810 - 08"  | 275          | 60        |
|                          |                            | TS-1010 - 10" | 345          | 60        |
|                          |                            | TS-1210 - 12" | 410          | 60        |
|                          |                            | TS-1810 - 18" | 655          | 60        |





| Door Accessories |  | Size | Code | Finish |         | Std. Pkg. |      |      |    |
|------------------|--|------|------|--------|---------|-----------|------|------|----|
| Kadi Tala        |  |      |      | NI     | PT      |           |      |      |    |
|                  |  |      |      | 200 MM | KDT 200 |           | 1055 | 1235 | 10 |
|                  |  |      |      | 275 MM | KDT 275 |           | 1170 | 1335 | 10 |

| Door Accessories |   | Size      | Code             | Finish<br>SS/PT | Std.<br>Pkg. |
|------------------|---|-----------|------------------|-----------------|--------------|
| ALDROP           |  | 200X16 MM | ALDSM (200X16)   | 565             | 10           |
|                  |   | 250X16 MM | ALDSM (250X16)   | 605             | 10           |
|                  |   | 300X16 MM | ALDSM (300X16)   | 755             | 10           |
| TADI             |  | 200X12 MM | SDH-TDH20012-304 | 505             | 10           |
|                  |   | 250X12 MM | SDH-TDH25012-304 | 565             | 10           |
|                  |   | 300X12 MM | SDH-TDH30012-304 | 655             | 10           |

| Door Accessories | Description   | MRP |
|------------------|---|-----|
| ME (B)           |  Magic Eye Big (Brass)   | 455 |
| MEF (S)          |  Magic Eye Small with Flap (Brass)   | 380 |
| DGBT             |  Door Guard Buckel Type (Brass)  | 870 |
| DS HR (SS)       |  Door Stopper Floor Mounted Half Round (SS 304)                              | 365 |
| DS HR (Z)        |  Door Stopper Floor Mounted Half Round (Zamak)                               | 210 |
| DB WC (22)       |  Door Buffer- Wall Mounted Dia 22mm Ht. 75mm with Cover (Stainless Steel)    | 285 |
| DB (22)          |  Door Buffer- Wall Mounted Dia 22mm Ht. 75mm without Cover (Stainless Steel) | 245 |
| DS HT            |  Door Stopper- Door Mounted Hanging Type (Brass)                             | 395 |
| DS HT (Z)        |  Door Stopper- Door Mounted Hanging Type (Zamak)                             | 340 |
| MDS-CL<br>MDS-GM |  Concealed Door Stopper (MAGNETO)  | 820 |

| Door Accessories | Description  | MRP |
|------------------|--|-----|
| DSC (M)          |  Door Safety Chain- Manually (Brass & Stainless Steel)   | 515 |
| BL (S)           |  Sliding Bolt (Baby Latch) with Stainless Steel Lock Strip 03" (Body in Zinc) | 225 |
| BL (B)           |  Sliding Bolt (Baby Latch) with SS Lock Strip 05"  | 365 |
| IB 390           |  Indicator Bolt  | 670 |
| DDDL             |  Double Door Attachment- For Dead Lock (Brass) - SS Finish   | 650 |
| DDML             |  Double Door Attachment- For Mortise Lock (Brass) - SS Finish   | 950 |
| DDML (ML170)     |  Double Door Attachment - For ML170 (Brass) - SS Finish  | 950 |
| DBPVC-W          |  Door Buffer 03" PVC White  | 50  |
| DBRB-B           |  Door Buffer 03" Rubber Black  | 50  |
| MDC SS304        |  Magnetic Door Catcher   | 500 |



| Code    | Straight Patch Fittings  | Description                     | MRP  |
|---------|--|---------------------------------|------|
| DPF-320 |   | Top Pivot                       | 315  |
| DPF-321 |   | Top Patch                       | 1815 |
| DPF-322 |   | Bottom Patch                    | 1815 |
| DPF-325 |  | Center Patch Lock with Cylinder | 3270 |

All Available in-PSS: Polished

# TERMS & CONDITIONS

Product prices are subject to change without prior notice.

● **Ordering Procedure**

- \* Order booking should be in multiples of standard packing wherever it is applicable.
- \* Orders to be placed as per the guidelines of the company.
- \* Orders should be placed in writing only
- \* Discount may vary from product to product. Refer the price list.

● **Title and Risk for Goods**

- \* Risk and Title in the Goods shall pass to the Purchaser upon the sooner of happening of the delivery to the delivery destination or upon the loading of the Goods on a third party vehicle or the Purchaser's vehicle for delivery to the delivery destination.
- \* Notwithstanding the above, the Company possess the lien on the Goods sold to the Purchaser until the Company receives payment in full for all Goods and for all money owing by the Purchaser to the company on any account whatsoever. The Company will have the right to recover the money due by selling the said goods to the third party or by taking back the goods to the Company premises as the circumstances prevail.

● **Return guidelines for the damaged / short supplied goods.**

- \* Any damaged or short material received must be immediately notified and any discrepancy must be clearly mentioned on pod/delivery receipt.
- \* No claim will be entertained in case discrepancy is not notified in writing immediately.
- \* No material for return shall be accepted by the company, in case valid claim is not filed in writing within 1 months of the date of invoice.
- \* All original packing material to be returned.
- \* All manuals and warranty registration cards must be unmarked. Upon receipt of return in accordance with the above terms, we shall issue a credit note.

All disputes are subject to Delhi Court.

Price list version - 2020/21

## OUR PRODUCT CODING SYSTEM

coding | LEVER HANDLES

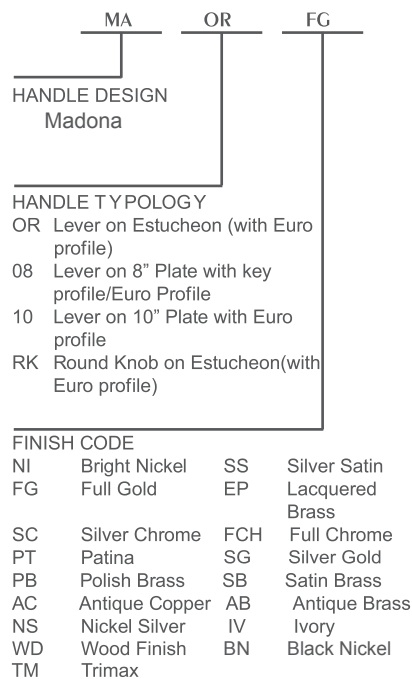

coding | PULL HANDLES

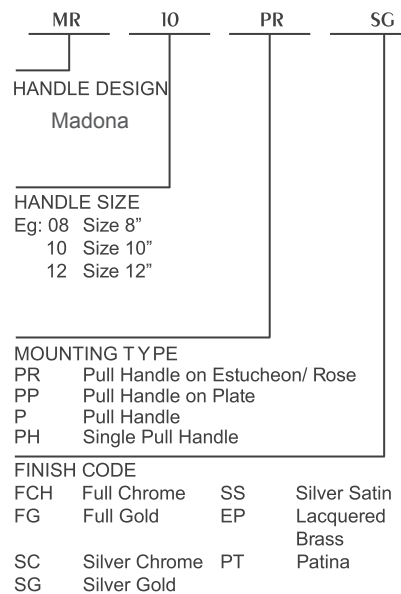

coding | EURO PROFILE CYLINDERS

|  | 60mm   | 70mm   | 80mm   | 90mm   | 100mm  |
|--|--------|--------|--------|--------|--------|
| Euro Profile Brass Cylinder (both side key)                              | CL 200 | CL 206 | CL 203 | CL 214 | CL 211 |
| Euro Profile Brass Cylinder (one side knob & one side key)               | CL 201 | CL 207 | CL 204 | CL 215 | CL 212 |
| Euro Profile Brass Cylinder (one side knob & one side emergency opening) | CL 202 | CL 208 | CL 205 | CL 216 | CL 213 |

Master key & Grand Master key available on request.

Finishes - Bright Nickel (NI), Silver Satin (SS), Patina (PT), Full Gold (FG), Lacquered Brass (EP).



**dorsët**  
we understand

# MAGNETO

## DOOR CATCHER

In Technical Collaboration with



NEW



**MDS-CL | MDS-GM**

### Magneto

*Magneto's major function is to operate as a trip hazard free, fully concealed, aesthetically pleasing doorstop.*

*Magneto's patented striker plate design not only allows for smooth activation and deactivation, it also hold's your door firmly in place as a world leading hold-open device door-stop.*

*With all components concealed either within the door or the floor, Magneto is 100% trip hazard free making it ideal for commercial, hospital, hotel, retirement and general use.*

WATCH PRODUCT DETAIL VIDEO ON YOUTUBE

**MRP:810/-**



### Magnet Causes Pin To Lift From The Floor Sleeve

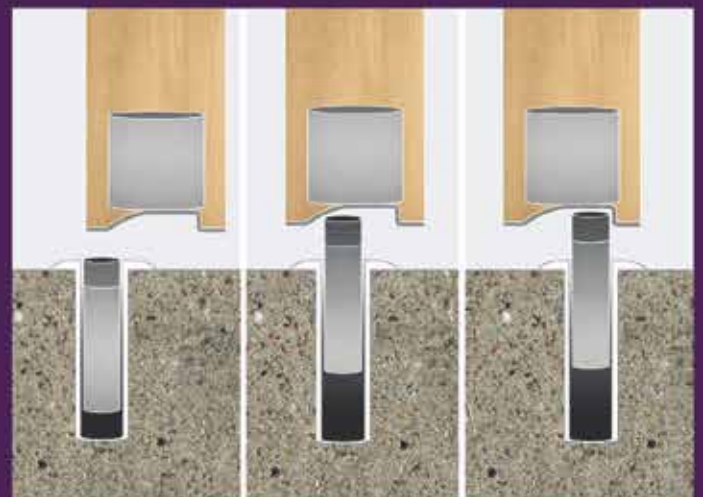



## Dorset Industries Private Limited

CIN:U29300DL2017PTC326885

**Corp. Office :**

AIHP Horizon | 445 | Udyog Vihar Phase V | Sector - 19 | Gurugram | Haryana | 122008 | INDIA  
Phones: + 91-124-4567890 | website : [www.dorsetindia.com](http://www.dorsetindia.com) | E-mail: [response@dorsetindia.com](mailto:response@dorsetindia.com)

**Branch Offices :**

Bengaluru | Hyderabad | Kolkata | Pune | Mumbai

**Works :**

Bhorakalan | Binola Industrial Area | NH-8 | Gurugram | Haryana | 122413

**Copyright © 2021  
ALL RIGHT RESERVED**

Reproduction or transmission in any form or by any means electronic or mechanical of this publication in part or whole is prohibited, including photocopy, recording or any other information storage and retrieval system, without prior permission from Dorset Industries Private Limited We reserve the right to make alteration to the model without prior notice. All sizes are finished as portrayed through photographs in this catalogue may vary from the actual product. Please check physical product before placing your order.

**dorsëtcare**  **Call at: 1800 11 4448**



SCAN TO DOWNLOAD ALL  
PRODUCT BROCHURES & PRICELISTS

[www.dorsetindia.com](http://www.dorsetindia.com)

Follow us on    